

GENERAL RULES

VERSION: JANUARY 15TH 2024



FUTURE ENGINEERS

ADVANCED ROBOTICS
FOLLOWING CURRENT
RESEARCH TRENDS

AGE GROUP:
14-19

WRO® 2024 SELF-DRIVING CARS

WRO INTERNATIONAL PREMIUM PARTNER



Table of Contents

1. General information	3
2. Team and Age Groups definitions.....	4
3. Responsibilities and team’s own work	4
4. Game documents and rule hierarchy	5
5. Game Description and Game Field.....	5
6. Surprise Rule	8
7. Engineer’s documentation on GitHub	8
8. Challenge rounds	10
9. Specific Game Rules.....	12
10. Scoring.....	16
11. Vehicle material & regulations	18
12. Competition Format & Rules	19
13. Game table and equipment.....	21
14. Glossary.....	24
Appendix C: Engineering journal evaluation	38
Appendix D: Minimal set of electromechanical components	42

Updates on the general rules from 2023 to 2024

Substantial changes and additions in the rules are marked in **yellow**. Because of the many changes in the rules no list is included. The biggest changes are:

- Introduction of a parallel parking challenge as part of the obstacle challenge
- Shortening the description of the randomization procedure

Please note, that during the season there might be clarifications or additions to the rules by the official WRO Questions & Answers. The answers are seen as addition to the rules.

You can find the WRO 2023 Q&A on this page:

<https://wro-association.org/competition/questions-answers/>

IMPORTANT: Use of this document in national tournaments

The rules in this document are used for the judging at international events.

This rule document is made for all WRO events around the world, but for the national competitions, a WRO National Organizer has the right to adapt these international rules to suit local circumstances. All teams participating in a national WRO competition should use the General Rules as provided by their National Organizer.

1. General information

Introduction

In the WRO Future Engineers category teams need to focus on all parts of the engineering process. The teams get points for documenting their process and making a public GitHub repository. **Every year a 20 to 30% change will be made to the challenges.** The whole challenge will change every 4-5 years.

In the Self-Driving Cars challenge a robotic vehicle needs to drive autonomously on a parkours that randomly changes for each competition round.

Focus Areas

Every WRO category has a special focus on learning with robots. In the WRO Future Engineers category, students will focus on developing in the following areas:

- Use of computer vision and sensor fusion to estimate the state of the parkours and the vehicle itself.
- A working vehicle with open-source hardware such as electromechanical components and controllers.
- Action planning and control of robots with moving parts and kinematics different from the differential drive (e.g., steering).
- Optimal strategies to solve the mission, including stability of mission solving.
- Teamwork, communication, problem solving, project management, creativity.
- An Engineering journal to show progress and design strategies.

For teams that are interested in participating in this category a Getting Starting guide was created. This guide explains more about the vehicle requirements, possible technical solution, and errors. Here students can start to get an idea of how-to setup a vehicle for this competition. [Look at the Getting Started guide here!](#)

Learning is most important

WRO wants to inspire students around the world for STEM related subjects and we want the students to develop their skills through playful learning in our competitions. Therefore, the following aspects are key for all our competition programs:

- ❖ Teachers, parents, or other adults can help, guide, and inspire the team, but are not allowed to build or code/program the robot.
- ❖ Teams, coaches, and judges accept our WRO Guiding Principles and WRO Ethics Code that should make all of us aware of a fair and learning full competition.
- ❖ On a competition day, Teams and Coaches respect the final decision judges take and work with other teams and judges on a fair competition.

More information on the WRO Ethics Code you find here: link.wro-association.org/Ethics-Code

2. Team and Age Groups definitions

- 2.1. A team consists of 2 or 3 students.
- 2.2. A team is guided by a coach.
- 2.3. 1 team member and 1 coach are not considered a team and cannot participate.
- 2.4. A team may only participate in one of the WRO categories in a season.
- 2.5. Any student may participate in one team only.
- 2.6. The minimum age of a coach at an international event is 18 years old.
- 2.7. Coaches may work with more than one team.
- 2.8. The age group for this category is defined for students in the age of 14-19 years old. (In season 2024: born years 2005-2010)
- 2.9. The maximum age reflects the age that the participant turns in the calendar year of the competition, **not** his/her age at the competition day.

3. Responsibilities and team's own work

- 3.1. A team should play fair and be respectful towards teams, coaches, judges, and competition organizers. By competing in WRO, teams and coaches accept the WRO Guiding Principles that can be found at: link.wro-association.org/Ethics-Code.
- 3.2. Every team and coach need to undersign the WRO Ethics Code. The organizer of the competition will define how the Ethics Code is collected and signed.
- 3.3. Coding of the vehicle and its construction (if applicable) may be done only by the team. The task of the coach is to accompany the team organizationally and to support them in advance in case of questions or problems, but not to do programming of the vehicle and its construction (if applicable) themselves. This applies to both the day of the competition and the preparation for the competition.
- 3.4. A team is not allowed to communicate in any way with people outside of the competition area while the competition is running. If communication is necessary, a judge may allow team members to communicate with others under supervision of a judge.
- 3.5. Team members are not allowed to bring and use mobile phones or any other communication device into the competition area.
- 3.6. Destruction or tampering with competition courts/tables, materials, or vehicles of other teams is prohibited.
- 3.7. It is not allowed to use a vehicle's control program that is (a.) the same or too similar to solutions sold online or (b.) the same or too similar to another solution at the competition and clearly not the own work of the team. This includes solutions from teams of the same institution and/or country. **Robot vehicles built from modular building kits and components will be checked for plagiarism. Since manufactured vehicles/sets can be used in the competition, these vehicles will not be checked for plagiarism.**
- 3.8. If there is a suspicion in relation to rule 3.3 and 3.7, the team will be subjected for investigation and any consequences as mentioned in 3.9 can apply. Especially in these cases rule 3.9.4 may be used to not allow this team to progress to the next competition, even if the team would win the competition with the solution that is likely not their own.

- 3.9. If any of the rules mentioned in this document are broken or violated, the judges can decide on one or more of the following consequences. Before, a team or individual team members may be interviewed to find out more about the possible violation of the rules. This can include questions about the vehicle or the program.
- 3.9.1. A team may not be allowed to participate in one or more challenge rounds.
 - 3.9.2. A team may get up to a 50% reduced score in one or more challenge rounds.
 - 3.9.3. A team may not qualify for the next round of the tournament.
 - 3.9.4. A team may not qualify for the national / international final.
 - 3.9.5. A team may be disqualified completely from the competition.

4. Game documents and rule hierarchy

- 4.1. Every year, WRO publishes a new version of general rules for this category including the concrete description of the self-driving vehicle game. These rules are the basis for all international WRO events.
- 4.2. During a season, WRO may publish additional Question & Answers (Q&As) that can clarify, extend, or re-define rules in game and general rule documents. Teams should read these Q&A's before the competition.
- 4.3. The general rule document and Q&A's may be different in a country due to local adaptations through the National Organizer. Teams need to inform themselves about the rules that apply in their country. For any international WRO event, only the information WRO has published is relevant. Teams that qualified for any international WRO event should inform themselves about possible differences to their local rules.
- 4.4. At the competition day, the following rule hierarchy applies:
 - 4.4.1. General rule document builds the basis for rules in this category.
 - 4.4.2. Questions & Answers (Q&A's) can overwrite rules in game and general rule documents.
 - 4.4.3. The head judge on the competition day has the final word in any decision.

5. Game Description and Game Field

The self-driving car challenges in this season are Time Attack races: there will not be multiple cars at the same time on the track. Instead, one car per attempt will try to achieve the best time by driving several laps fully autonomously. The two challenges are the following:

Open Challenge: The vehicle must complete three (3) laps on the track with random placements of the inside track walls.

Obstacle Challenge: The vehicle must complete three (3) laps on the track with randomly placed green and red traffic signs. The traffic signs indicate the side of the lane the vehicle must follow. The traffic sign to keep to the **right side** of the lane is a **red pillar**. The traffic sign to keep to the **left side** of the lane is a **green pillar**. The continuation of the vehicle to the third round is indicated by the last traffic sign of the second round. A green traffic sign indicates that the robot must go ahead and continue the third round in the same direction. A red traffic sign indicates that the vehicle must turn around and complete the third round in the opposite direction. The vehicle

should not move any of the traffic signs. After the robot completed the three rounds, it has to find the parking lot and has to perform parallel parking.

The starting direction in which the car must drive on the track (clockwise or counter clockwise) will vary in different challenge rounds. The starting position of the car as well as the number and location of traffic signs are randomly defined before the round (after the check time). The following graphic shows the game field with the game objects.

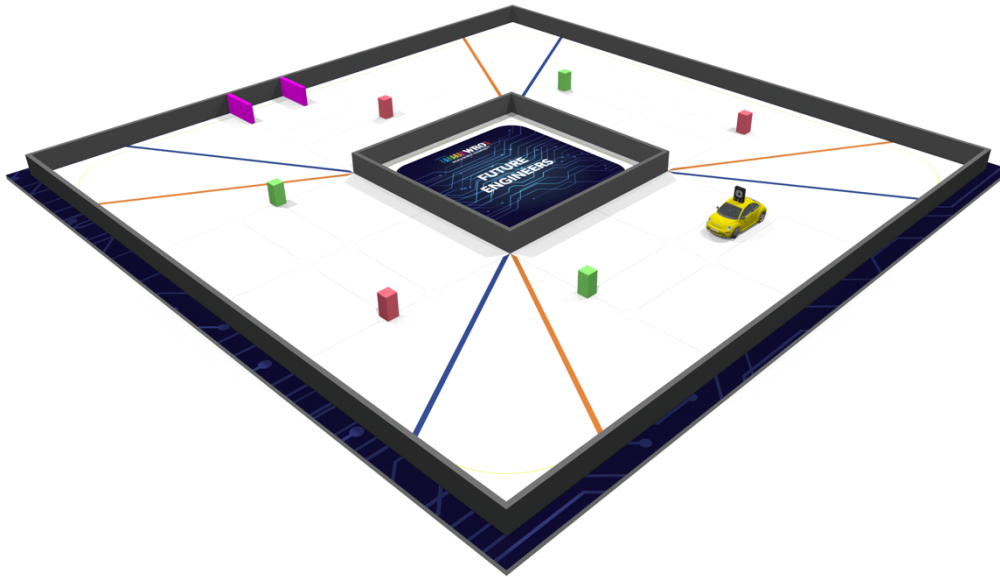

Figure 1: Detailed game field

The game field represents a racetrack where traffic signs (represented by the coloured obstacles - pillars) are set up.

The track consists of eight sections: four corner sections and four straightforward sections. Corner sections are marked with red dashed lines on the next Figure. Straightforward sections are marked with blue dashed lines.

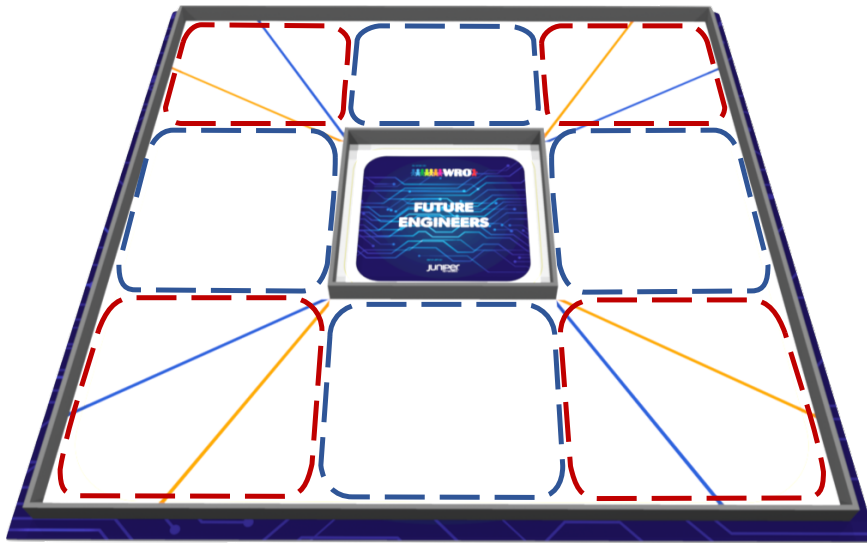

Figure 2: Different types of sections on the game field

Every straightforward section is divided into 6 zones. Six internal zones within the section are for starting position of the car. 4 T-intersections and 2 X-intersections are used to position the traffic signs. The places where the traffic signs can be set up are called traffic signs' seats.

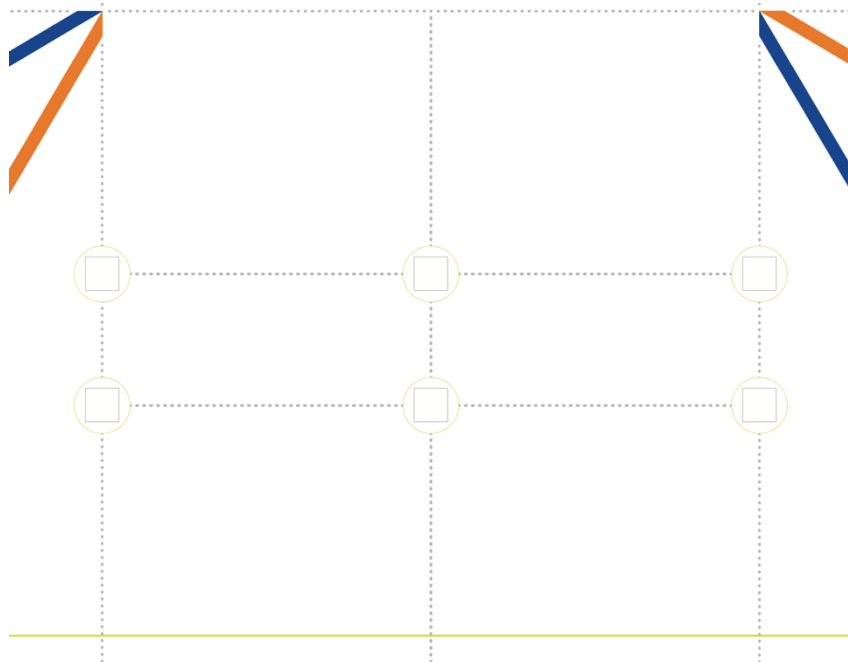

Figure 3: Zones and traffic signs' seats in the straightforward section

It is possible, that a parking lot is placed in one of the straight forward sections. The width of the parking lot is always 20 cm. The length is variable and calculated: $1,25 * \text{length of the robot}$

The parking lot is limited by two wood elements with 20 cm x 2 cm x 10 cm in magenta. The right element is placed right next to the dotted line. The position of the left one is defined as described above.

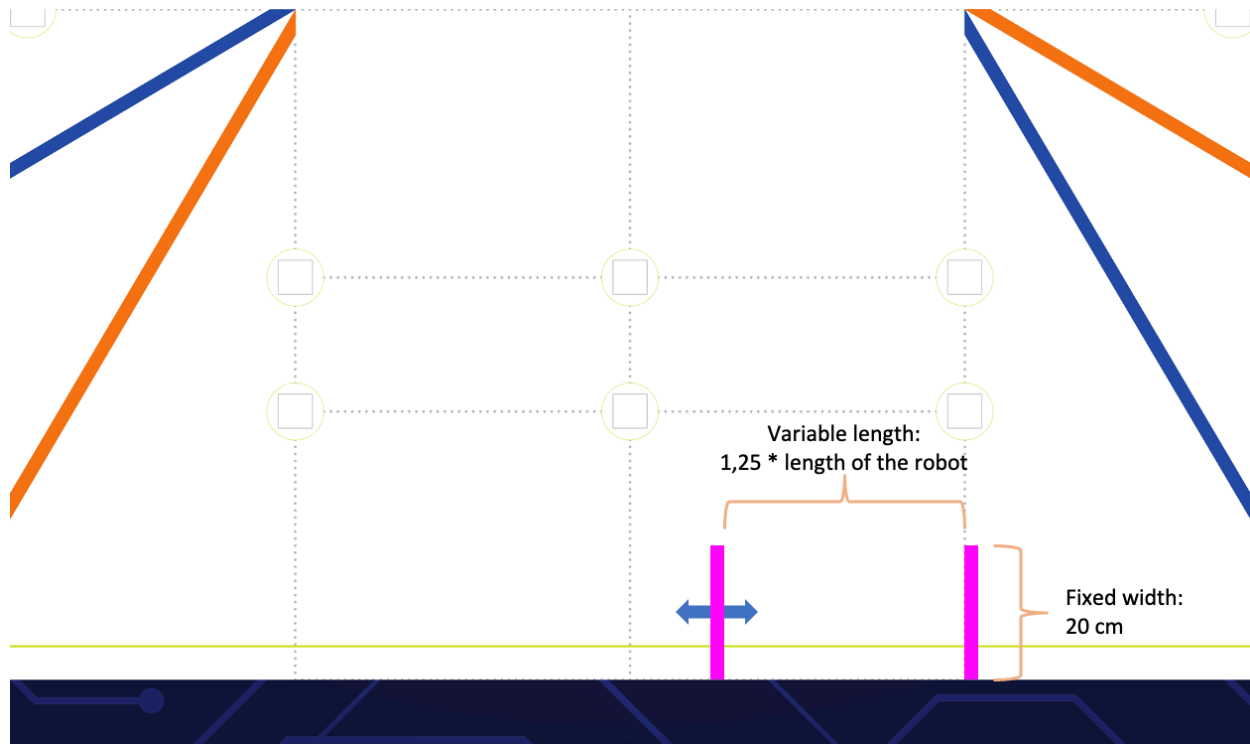

Figure 4: Definition of size of the parking lot

6. Surprise Rule

A surprise rule for the international competition can be announced before the International Final. This rule can add / modify / change existing rules and the qualified teams would have time to prepare before the event.

7. Engineer's documentation on GitHub

Real engineering is about creating a solution and communicating or sharing the idea with others to bring the whole idea a step further. In addition to designing and programming the vehicle, teams must provide documentation that presents their engineering progress, the final vehicle design and final vehicle source code. This documentation must be uploaded to the GitHub public repository, and a hardcopy must be submitted at the international final. Details about the scoring of the documentation can be found in Appendix C of this document. **For the international competition, all information and documentation on GitHub must be done in English.**

Each team must provide the following:

- Discussion, **information** and motivation for the vehicle's mobility, power and sense, and obstacle management.
- Photos of the vehicle (from every side, from top and bottom), and a team photo.
- URL to YouTube (should be either public or accessible by link) showing the vehicle driving autonomously. That part of the video where driving demonstration exists, must be at least 30 seconds in length. One video for each challenge must be provided.

- Link to a GitHub **public** repository with the code for all components which were programmed to participate in the competition. The repository may also include the files for models used by 3D printers, laser cutting machines and CNC machines to produce the vehicle elements. The history of commits should contain at least 3 commits:

- the first commit not later than 2 months before the competition – it must contain not less than 1/5 of the final amount of the code.
- The second commit not later than 1 month before the competition,
- The third commit not later than 2 weeks before the competition.
- More commits are allowed.

The repository must contain a README.md file with a short description in English (not less than 5000 characters) of the designed solution. The goal of the description is to clarify which modules the code consists of, how they are related to the electromechanical components of the vehicle, and what is the process to build/compile/upload the code to the vehicle's controllers. A template for the GitHub repos is available on <https://github.com/World-Robot-Olympiad-Association/wro2022-fe-template>.

The repository has to be public from the moment when it is submitted for an international competition and has to stay public at least 12 months after the competition. The idea of Future Engineers is to encourage new teams and support them in finding existing solutions and get inspired by them. If a repository is not public before the event, the team will get reduced points for the documentation. WRO Association has the right to republish the repository at any time.

- GitHub repositories must be set for public viewing.
- Code provided on GitHub and Hard Copy must be well documented with comments in the code. Judges might not have access to the specific programs used by teams to develop their code, e.g. EV3, Spike or Scratch.

8. Challenge rounds

For the *International Final* there will be four rounds, two for the Open Challenge and two for the Obstacle Challenge. The direction for each challenge round, **the starting position, and the layout of the track** will be chosen randomly. The direction in which the vehicle must move during the challenges is defined as the challenge driving direction.

Open Challenge rounds

During Open Challenge rounds, the racetrack will have no traffic signs.

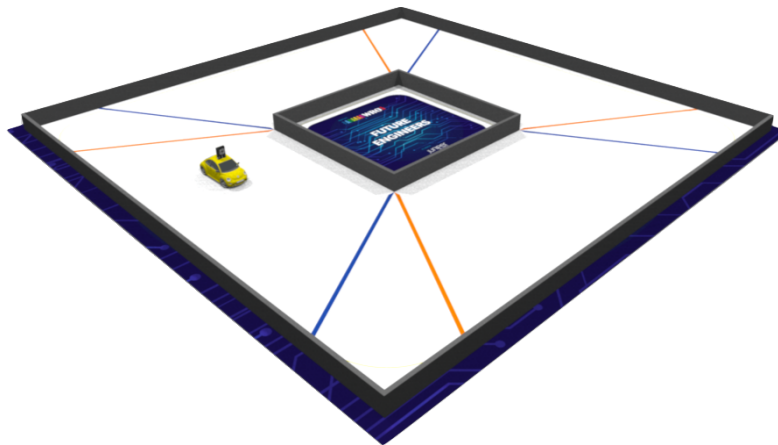

Figure 5: The game field for challenge one rounds

The distance between the track borders could be either 1000 mm or 600 mm (+/- 100 mm for the International Final).

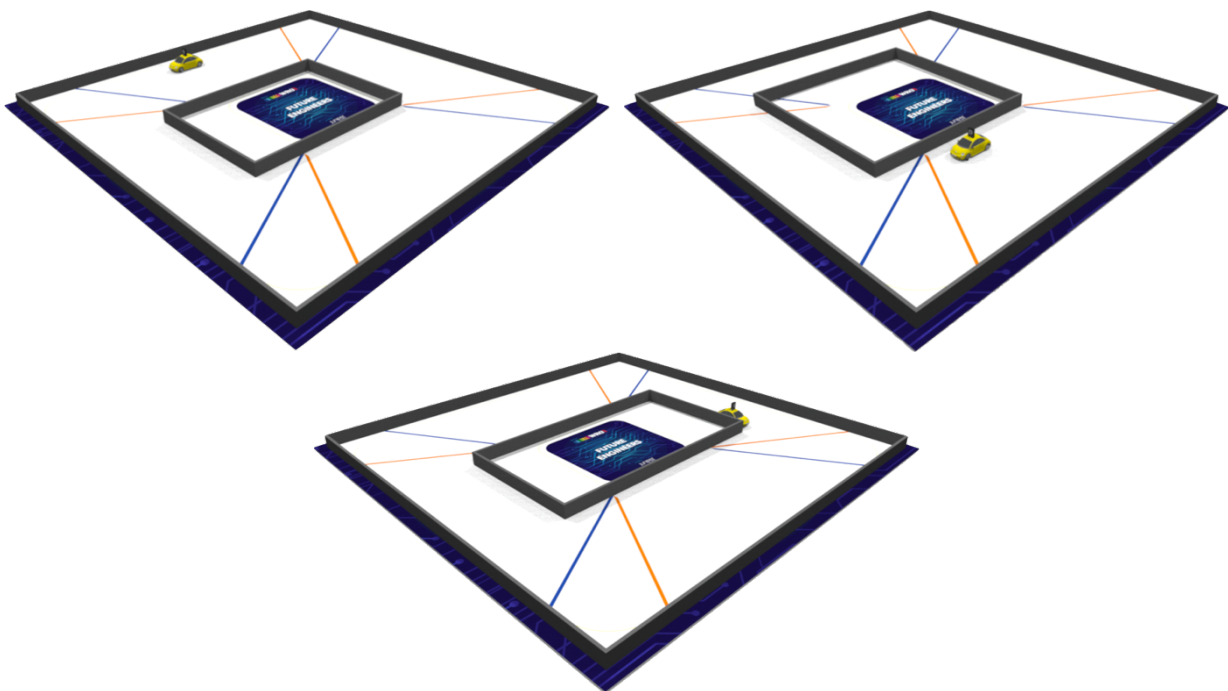

Figure 6: Examples of the game field variation for Open Challenge rounds

Obstacle Challenge rounds

During Obstacle Challenge rounds, the red and green pillars will be set up on the racetrack as the traffic signs. In addition, two boundaries will be placed and form a parking lot. The distance between the track borders will be always 1000 mm (+/- 10 mm for the International Final).

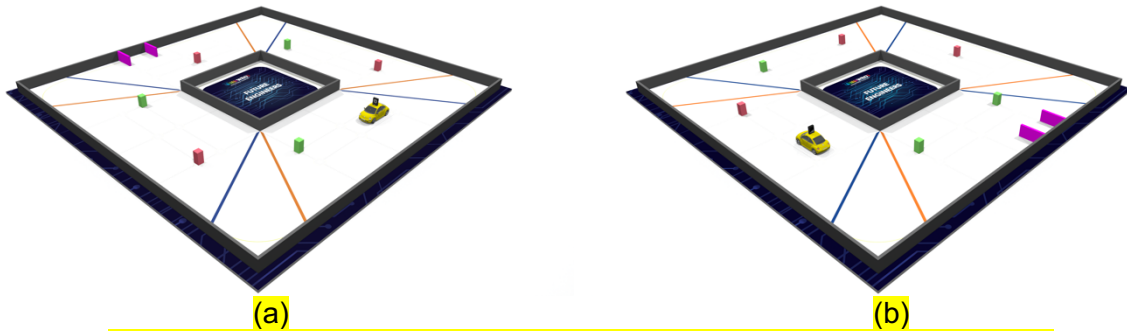

Figure 7: Examples of the game field for Obstacle Challenge rounds

In the straight section with the parking lot, no traffic signs can be placed on the positions close to the outer wall. This avoids, that traffic signs block the access to the parking lot.

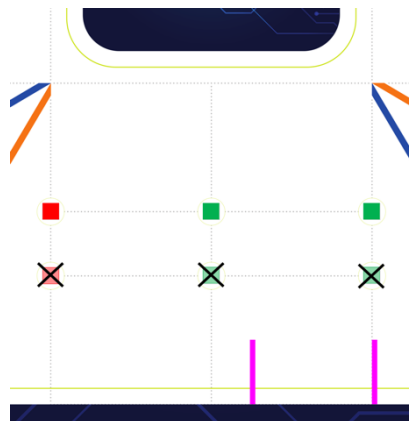

Figure 8: Allowed and forbidden positions for traffic signs near a parking lot

Randomization

At the international competition, multiple randomizations with the layout for Open and Obstacle Challenge rounds will be prepared. One of them will be drawn after the robot check, directly before the round.

The following configurations are randomized:

Open Challenge: Driving direction, starting position, placement of the inner walls

Obstacle challenge: Driving direction, starting position, Number and positions of the traffic lights, position of the parking lot

9. Specific Game Rules

Challenge Round Timing

- 9.1. Open Challenge rounds will be three minutes in length.
- 9.2. Obstacle Challenge rounds will be three minutes in length.

Start Configuration

- 9.3. The direction to drive the track is chosen randomly before each Challenge round in the series, after the check time.
- 9.4. The starting position of the vehicle and the field configuration are determined before starting every round, after the check time.
- 9.5. The direction to drive, starting position, and the field configuration remain the same for all teams during the same round.

Round Start

- 9.6. The vehicle is placed in the starting zone totally **SWITCHED OFF!**
- 9.7. The position of the vehicle in the starting zone must be so the projection of the car on the game mat is completely within the start zone.
- 9.8. The vehicle must be oriented so that the two wheels on the front axle (the judges must ask the team in advance which is axle is a front one) are located closer to the next corner section in the round driving direction whereas other two wheels are located closer to the corner section in opposite direction.
- 9.9. Physical adjustments can be made (this is part of the preparation time). However, it is not allowed to enter data to a program by changing positions or orientation of the vehicle parts or to make any sensor calibrations on the vehicle. It is not allowed to enter data by changing the switches configuration, if any. If a team does enter data through physical adjustments, it will be disqualified for that round.
- 9.10. The vehicle is then switched on. Only one switch is allowed to switch the vehicle on.
- 9.11. After vehicle is switched on, the vehicle should then be in a waiting state. Waiting for a Start button to be pressed. The Start button could be on the main SBC/SBM or a separately installed Push Button. Only one Start button is allowed. **On an EV3, only one program will be allowed. The run button must be pressed to start the last program that was run on the EV3. The EV3 must then wait for a start button to be pressed. The start button on the EV3 can be a touch sensor or the right arrow button. On a Spike robot only Slot One can be used. The same procedure for the EV3 must be followed.**
- 9.12. **It is the responsibility of the team to check the layout of the racetrack and make sure it is correct. The judge will ask if the team is ready. The team must answer Yes to show their acceptance of the racetrack layout. No re-starts will be allowed if the team realised after the start, that the racetrack layout was not correct.**
- 9.13. A judge gives the signal to start the vehicle. Judge will count “Three, two, one, Go”. On the “Go” command the starting button is then pressed and the time for the attempt is started. The vehicle will have the amount of time to complete the round that is mentioned in the Game Rules.
- 9.14. Pressing the start button must start the vehicle action to attempt the challenge round and the vehicle should start moving.

Additional Pieces

- 9.15. The vehicle is not allowed to leave additional pieces on the game field or leave marks that are not removable (e.g., paint) during the round intentionally. If the vehicle violates this rule, the round will be stopped, and the vehicle must be stopped by one of the team's members. The score for this round will be zero and the time mark will be the maximum. The judges have the right to inspect the team's code if they suspect such a situation.

During the Round

- 9.16. The vehicle must drive in the direction that was defined as the challenge driving direction before the challenge start.
- 9.17. The vehicle's dimensions must not exceed 300x200 mm and 300 mm in height.
- 9.18. The vehicle is not allowed to **move** the walls (if they are not completely fixed on the field). The vehicle that violates this rule will be stopped by one of the team's members, the score for this round will be zero and time mark will be the maximum. If the vehicle touches or bumps the walls, and the walls **are not moved**, the vehicle may continue the round, and no penalties will be incurred. If the vehicle bumps or touches the walls and the vehicle stops, as a result of bumping or touching, a repairing action can be done, and penalties will be incurred. **During the open challenge rounds the vehicle may not touch the outer boundary wall.**
- 9.19. The vehicle must pass the traffic sign represented by the red pillar on the right (the picture a) and the traffic sign represented by the green pillar on the left (the picture b). **The appendix A section 5 defines, when a traffic light was passed on the wrong side and how it is scored.**

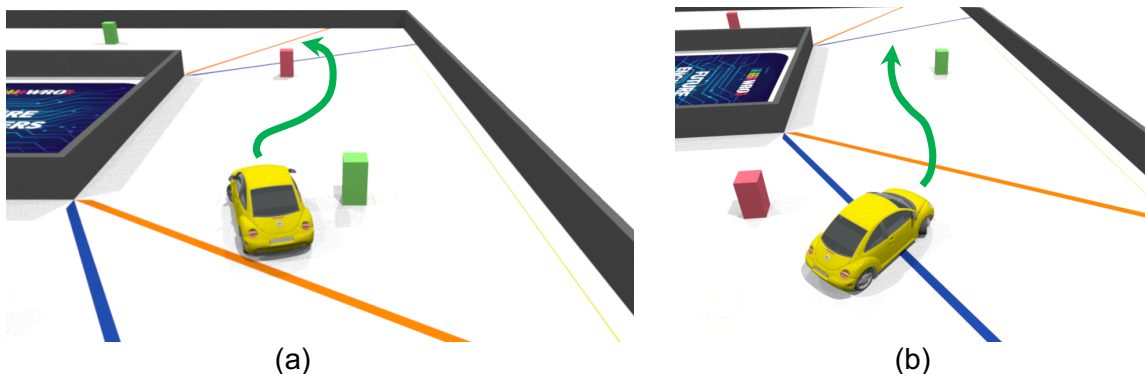

Figure 9: The rules to pass the traffic signs

- 9.20. The vehicle is allowed to **touch**, move or knock down the traffic signs (coloured pillars) while the projection of the traffic sign is within the circle drawn around the traffic sign's seat. For more details refer to Appendix A, section 1.
- 9.21. The vehicle is allowed to drive in the direction opposite to the round driving direction for two sections only: the section where the direction was changed and the neighbouring section.
- 9.22. The vehicle must return to the starting section after driving three laps to get additional points. Note: as soon as the vehicle partially leaves the starting section this section also becomes the finish section.
- 9.23. Once per round the team can ask permission for repairing actions: to take the vehicle

out, fix the issue with mechanical or electronic parts, and put the vehicle back to the track in the centre of the section the vehicle was taken out of. The vehicle may be switched off when it is removed from the track. The vehicle may be switched on after it is put down on the track. The vehicle may then be switched on and put into motion again by pressing the start button. The round timer will not be stopped for the repairing action. The permission can be granted only if the vehicle has stopped. Possible reasons for the stop, are issues with electronics/mechanics or because the vehicle hit the wall and is stuck, or the vehicle just stops for no reason. The permission will not be granted for a moving vehicle – if any of its parts drives for approximately 50 mm in 5 seconds. The permission will not be granted if the vehicle has started the third lap (completely passed the corner section before the last lap). It is not allowed to upload programs on any controller of the vehicle as part of repairing actions. It is not allowed to enter any data. The team that violates these rules will be disqualified from this round: the score for this round will be zero and the time mark will be the maximum.

Round End:

- 9.24. The round ends and time is stopped if any of the following conditions occurs:
- 9.24.1. The round timer expires.
 - 9.24.2. **In Open Challenge:** After three complete laps the vehicle stops in the finish section so that the projection of the vehicle on the field is completely within the section. For more details refer to Appendix A, section 2.
***Note 1:** the vehicle must stop in the finish section autonomously. If team participant forces the end of the round by using one of the methods described below when the vehicle is within the finish section, this will not be considered an autonomous stop and points for stopping in the finish section will not be assigned.*
***Note 2:** to demonstrate a complete stop in the finish section, the vehicle must not continue driving after 15 seconds. If after the end of the round the vehicle continues moving, judges could find the behaviour of the vehicle ambiguous and may not assign a point for the stop in the finish section.*
 - 9.24.3. **In Open Challenge:** After three complete laps the vehicle passes the finish section so that its projection on the mat is completely within the corner section next to the finish section in the round driving direction. For more details refer to Appendix A, section 3. The vehicle crosses section boundaries twice while driving in the direction which is opposite to the round driving direction. For more details refer to Appendix A, section 4.
 - 9.24.4. **In Obstacle Challenge:** After 3 rounds have been completed correctly, the vehicle stops. Either in the correct section or in the parking lot.
 - 9.24.5. **In Obstacle Challenge:** After passing a traffic sign from the incorrect side, the vehicle completely crosses the line which goes from the inner border to the outer border and where this traffic sign is located. For more details refer to Appendix A, section 5.
 - 9.24.6. **In Obstacle Challenge:** The robot moved a traffic sign outside of the circle.
 - 9.24.7. **In Obstacle Challenge:** The robot touches the parking lot limitations.
 - 9.24.8. The vehicle's dimensions still exceed the limit, after 3-minute repairing time.
 - 9.24.9. Any team member touches the vehicle without the judge's permission for repairing actions.
 - 9.24.10. Any team member touches the field mat and wall without the judge's permission

for repairing actions.

- 9.24.11. Any team member touches the game elements.
- 9.24.12. The vehicle drives outside of the track (by moving the wall) or outside of the game field.
- 9.24.13. The vehicle or team member damages the field or a game element.
- 9.25. Notice that, according to the above rules, the team can stop their attempt (e.g., by touching the field wall or doing any of the above rules). However, they will not be able to resume the attempt after the stop and the round will be ended.
- 9.26. The judges will base their decisions on the rules and fair game play. They have the final decision on the competition day. If there is any uncertainty during the task completion, the judges will bias their decision to the worst outcome available for the context of the situation,

10. Scoring

- 10.1. The official score will be calculated at the end of each challenge round.
- 10.2. The maximum score is calculated as follow:
- 10.2.1. 30 points for the Open Challenge round. (1.1 + 1.2 + 1.3)
 - 10.2.2. 70 points for the Obstacle Challenge round. (1.1 + 1.2 + 1.3 and either 1.4 (or 1.5) or 1.6 (or 1.7) + 1.8 + 1.9)
 - 10.2.3. 30 points for the engineering journal documentation
 - 10.2.4. Maximum score is 130. (≈ 75% vehicle performance and ≈ 25% documentation)

	Requirements	Point value	Total available
1.	Driving Open and Obstacle Challenge		
1.1.	The vehicle drives from a section in the challenge driving direction. This is applicable for the starting section, but not applicable for the finish section and other section next after it.	1	24
1.2.	The vehicle drives a full lap. 8 sections were passed successfully in the challenge driving direction. The starting section is included in the eight sections for the first lap. The lap is considered as completed if the vehicle completely drives out of the last (corner) section in the lap. So, the vehicle can start moving in the opposite direction after this and the lap will be still considered.	1	3
1.3.	After the completion of three laps the vehicle stopped in the finish section.	3	3
	Additional points for Obstacle Challenge rounds:		
	Not completed three laps		
1.4	One or more traffic signs were moved. Vehicle must complete at least one round to qualify for score.	2	2
1.5.	The traffic signs were not moved. Vehicle must complete at least one round to qualify for score.	4	4
	After the completion of three laps		
1.6	One or more traffic signs were moved.	8	8
1.7	No traffic signs were moved.	10	10
1.8	Final lap completed in the correct direction	15	15
1.9.1	Parking successfully (completely in the parking area)	15	15
1.9.2	Parking partly in the parking area	7	7
2.	The team performed repairing actions by taking the vehicle out of the field even if the actions were not successful.	Total round points divided by factor 2	
3.	Engineering journal and vehicle documentation Refer to appendix C for a breakdown of the engineering journal scoring.		30

- 10.3. The time measured by a judge, the moment of the open challenge round ends, is written down and will be later used to identify the best round. If a team or vehicle was disqualified for the challenge round, the maximum time (3 minutes) is given for such a challenge round.
- 10.4. The score calculation is done by the judges at the conclusion of each challenge round. The team must verify and sign the score sheet after the round if they have no fair complaints.

- 10.5. The teams' ranks for Open Challenge rounds are based on points each team received in their best Open Challenge rounds. If a team has the same score in both rounds, the round with the smallest time will be chosen as the best Open Challenge round.
- 10.6. All teams will compete in both challenge rounds.
- 10.7. The teams' ranks for overall competition are built based on the sum of each team's points received in the best Open Challenge round, points received in the best Obstacle Challenge round and points received for the engineering journal and vehicle documentation. If a team has the same score in both Obstacle Challenge rounds, the round with the quickest time will be chosen as the best Obstacle Challenge round.
- 10.8. If there is a tie between two teams, ranking will be determined by considering the following results (the first in the list is the highest priority, the last in the list is the lowest priority):
 - 10.8.1. Sum of points received in Open Challenge round, points received in the Obstacle Challenge round and points received for the engineering journal and vehicle documentation
 - 10.8.2. Points of the best Obstacle Challenge round
 - 10.8.3. Time for the best Obstacle Challenge round
 - 10.8.4. Points of the second-best Obstacle Challenge round
 - 10.8.5. Time for the second-best Obstacle Challenge round
 - 10.8.6. Points for the engineering journal and vehicle documentation
 - 10.8.7. Points for the best Open Challenge round
 - 10.8.8. Points of the second-best Open Challenge round
 - 10.8.9. Time for the best Open Challenge round
 - 10.8.10. Time for the second-best Open Challenge round

11. Vehicle material & regulations

- 11.1. The vehicle's dimensions must not exceed 300x200 mm and 300 mm in height.
- 11.2. The weight of the vehicle must not exceed 1.5 kilograms.
- 11.3. The vehicle must be a 4 wheeled vehicle with one driving axle and one steering actuator of any type. It must be either front-wheel drive (https://en.wikipedia.org/wiki/Front-wheel_drive), rear-wheel drive (https://en.wikipedia.org/wiki/Rear-wheel_drive) or four-wheel drive (https://en.wikipedia.org/wiki/Four-wheel_drive). Teams with vehicles that use the differential wheeled base (https://en.wikipedia.org/wiki/Differential_wheeled_robot) will be disqualified. **Driving** – making the vehicle move forward and backward. **Steering** – turning the vehicle to the left or to the right.
- 11.4. The vehicle cannot use any kind of an omnidirectional wheel, ball caster or spherical wheel.
- 11.5. A vehicle must be autonomous and finish the “missions” by itself. Any radio communication, remote control, and wired control systems are not allowed while the vehicle is running. Teams in violation of this rule will be disqualified.
- 11.6. Participants are not allowed to interfere with or assist the vehicle while it is running (performing the "mission"). This includes entering data to a program by giving visual, audio or any other signals to the vehicle during the round. Teams that violate this rule will be disqualified at that round.
- 11.7. The controller used for the vehicle can be either Single board computer (SBC) (https://en.wikipedia.org/wiki/Single-board_computer) or Single board microcontroller (SBM) (https://en.wikipedia.org/wiki/Single-board_microcontroller) with no restriction on brand.
- 11.8. There could be more than one SBC/SBM on the vehicle.
- 11.9. Teams cannot use any kind of RF, Bluetooth, Wi-Fi, or any kind of wireless communication components in their vehicles during the competition rounds. If it is built-in on the controller, it must be turned off and the judges can inspect the code and the vehicle to confirm that it is not used by any means.
- 11.10. Teams can use any sensors of their choice – there are no restrictions on brand, function or number of sensors used. Cameras are considered sensors.
- 11.11. Teams can use any electrical DC motors and/or servo motors of their choice – there are no restrictions on brand of motors and/or servos used.
- 11.12. A maximum of two motors may be used to make the vehicle move forward or backward (i.e., driving the robot, these are the driving motors). The driving motors must all be connected directly to the axle turning the wheels, or indirectly through a gearing system. The two driving motors may not be connected independently of each other to the driving wheels.
- 11.13. Teams can use any electronic components – there are no restrictions on the type, company, number, or the purpose.
- 11.14. Teams can use any hydraulic pressure, barometric pressure equipment or solenoids.
- 11.15. Teams can use any battery of their choice – there are no restrictions on brand, function or number of batteries used.
- 11.16. Only wire connections are permitted for communication between vehicle electromechanical components.

- 11.17. Teams can use 3D printed elements, elements prepared with a CNC machine, elements cut from acrylic/wood/metal or any elements from any material – there are no restrictions on the purpose.
- 11.18. The vehicle can be built using any type of hardware kits and any material. There is no restriction on a specific type or a specific building system.
- 11.19. Teams can use electrical tape, elastic bands, cable wraps, nylon ties (tie wraps), etc. Any adhesive material is allowed to be used for any purpose.
- 11.20. Teams should bring enough spare parts. In the case of any accidents or equipment malfunction, WRO (and/or organizing committee) is not responsible for their maintenance or replacement.
- 11.21. Vehicles may be assembled before the tournament.
- 11.22. Control software can be written in any programming language – there are no restrictions on a specific language.
- 11.23. Contestants may prepare the program beforehand.
- 11.24. Teams should prepare and bring all the equipment, software, and portable computers they need during the tournament.
- 11.25. The team is allowed to have only one vehicle for competition day. No spare vehicles are allowed inside the competition area.

12. Competition Format & Rules

The description in this document explains how the competition will be done at the International Final. National and regional competitions can use this model or customise this model for their own competitions.

- 12.1. The competition consists of several challenge rounds with practice time in between. After each practice time, there will be a vehicle check time to review the requirements.
- 12.2. Each team must work during practice time in their specified place until the check time, when the team's vehicle must be placed in a designated area (checking area).
- 12.3. On the day of the competition, there will be a minimum of 60 minutes of practice time before the start of the first round.
- 12.4. Teams cannot touch the designated competition areas before the start of the practice time is announced.
- 12.5. During practice time, the contestants may work in their places, or may queue with their vehicles to have one test attempt on the game field or may take measurements in the game field in so far as this does not interfere with other teams' test attempts. The maximum time allowed per team for one practice attempt is 4 minutes. After 4 minutes a team may fall in at the back of the que for another practice attempt. Teams are allowed to make changes to the program or to adjust the vehicle mechanically.
- 12.6. All vehicles must be placed on the reviewing table in the checking area for preparatory review (vehicle check) after the end of the practice period. **All controllers of the vehicle must be powered off.** No mechanisms or programs may be modified after this time.
- 12.7. Vehicles may take part in the competition only after they have passed the vehicle check. The check is concerning the requirements to the vehicle and materials used, as described in the sections above.

- 12.8. If a vehicle does not pass the vehicle check by the judges, the judges may provide a team up to 3 minutes to address issues found. Only one three minutes period can be provided by judges for a team per each check time slot.
- 12.9. If eventually a vehicle does not pass the vehicle check by the judges, the vehicle may not be used in the competition.
- 12.10. The team cannot exceed 90 seconds for preparation as soon as they are called by judges for participating in a particular challenge round, and once started, individual rounds may not exceed the challenge round time specified in the Game Rules.

13. Game table and equipment

Game Table & Field

- 13.1. Size of the game mat is 3200 x 3200 mm (+/- 5 mm). The internal square within the game mat is the racetrack with inner size 3000 x 3000 mm (+/- 5 mm).
- 13.2. The main colour of the track is white.
- 13.3. The track is surrounded by (exterior) walls with inner height 100 mm.
- 13.4. The inner colour of the exterior walls is black. The outer colour of the walls is not defined.
- 13.5. There exist additional (interior) walls surrounding the internal section of the track with the height 100 mm.

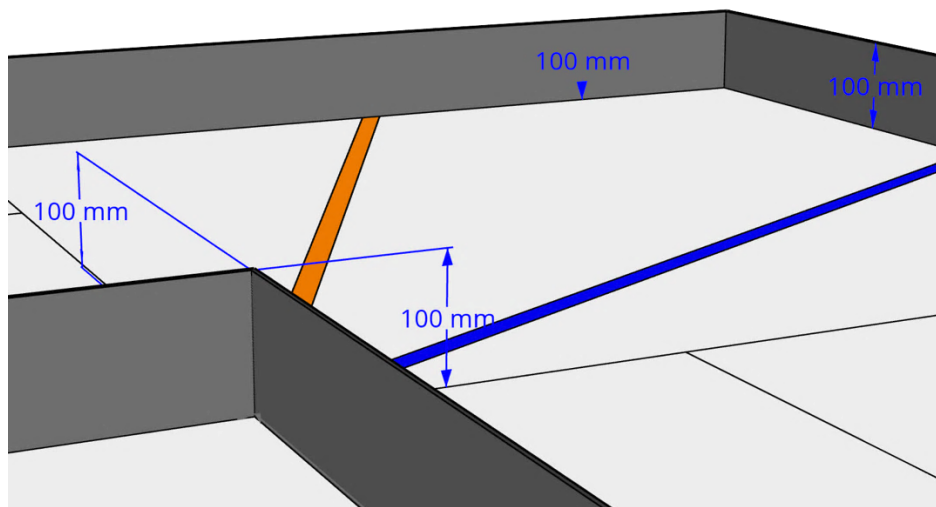

Figure 10: Height of the exterior and interior walls

- 13.6. The outer colour of the interior walls is black. The inner colour of the walls is black. The colour of the top edge of the walls is black.
- 13.7. The thickness of both exterior and interior walls is not defined.
- 13.8. The distance between exterior and interior walls depends on the round type and is specified in the Game Alternatives section.
- 13.9. There are orange and blue lines on the track. The thickness of the lines is 20 mm. The colour of the orange lines is CMYK (0, 60, 100, 0). The colour of the blue lines is CMYK (100, 80, 0, 0).
- 13.10. There are dashed lines with thickness 1 mm on the field to bound the vehicle's starting zones. The colour of dashed lines is CMYK (0 0 0 30).
- 13.11. The size of every starting zone is 200 x 500 mm.
- 13.12. There are squares to identify places where traffic signs could be located. The line thickness of the traffic sign seat is 1 mm, and the colour of the line is CMYK (0 0 0 30).
- 13.13. The size of every traffic sign seat is 50x50 mm.
- 13.14. The area to evaluate if a traffic sign is moved is specified as a circle around the corresponding traffic sign's seat. The thickness of the circle line is 0.5 mm. The colour of the lines is CMYK (20 0 100 0).
- 13.15. The diameter of the circle is 85 mm.

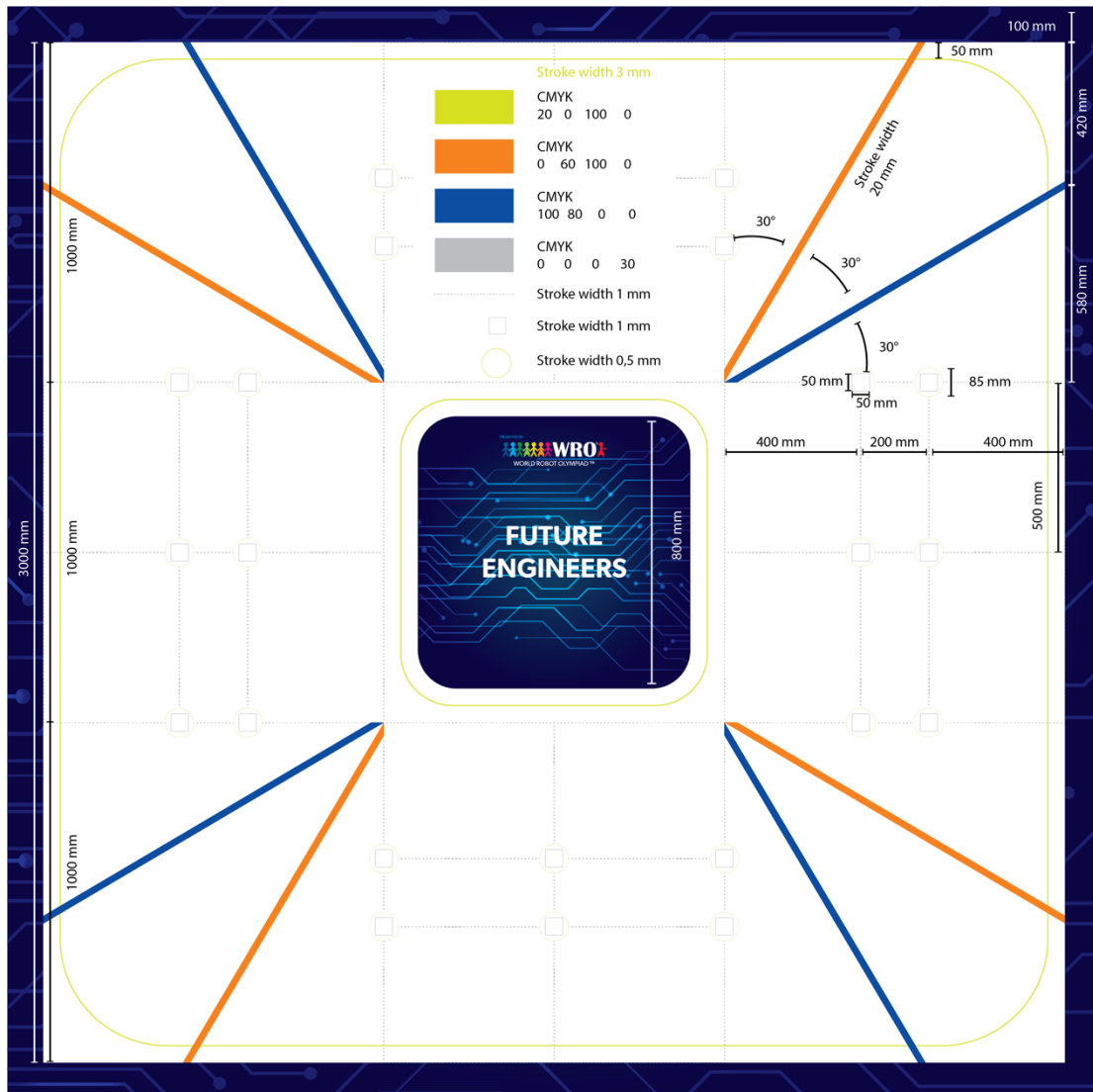

Figure 11: The game field map with sizes

Walls configuration for the International Final

- 13.16. The inner walls will be placed in a square or rectangular shape according to the draw. The outer walls will be fixed in a square shape and will not change during challenges.
- 13.17. The colour of the walls will be black.
- 13.18. Although everything will be done by the organisers get the colours of the field mat and field objects as close as possible to the CMYK specification, differences might still appear. Teams will have the opportunity to calibrate and fine tune their vehicles to the colours on the board and field objects during testing rounds.

Traffic Signs

- 13.19. Every traffic sign is a rectangular parallelepiped with dimensions 50x50x100 mm.
- 13.20. Depending on the randomization process before every round there could be up to 7 red parallelepipeds and up to 7 green parallelepipeds.
- 13.21. The colour of the red traffic signs is RGB (238, 39, 55).
- 13.22. The colour of the green traffic signs is RGB (68, 214, 44).
- 13.23. The material of the traffic sign is not defined.
- 13.24. The weight of the traffic sign is not defined.

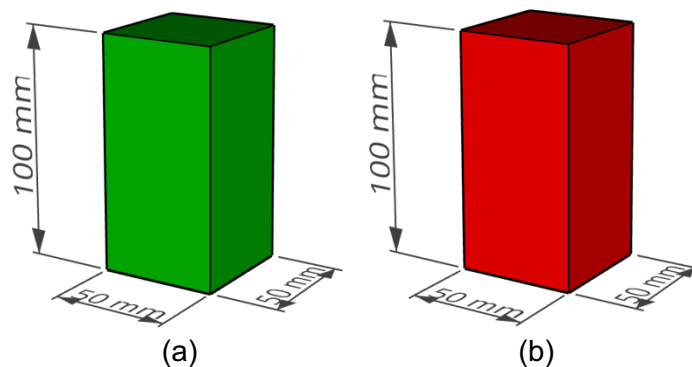

Figure 12: Dimensions of the traffic signs

Parking lot limitations

- 13.25. Every parking lot limitation is a rectangular parallelepiped with dimensions 200x20x100 mm.
- 13.26. One parking lot with two parking lot limitations is in each obstacle challenge round placed on the mat.
- 13.27. The colour of the parking lot limitation is magenta / RGB (255, 0, 255).
- 13.28. The material of the traffic sign is not defined.
- 13.29. The weight of the traffic sign is not defined.

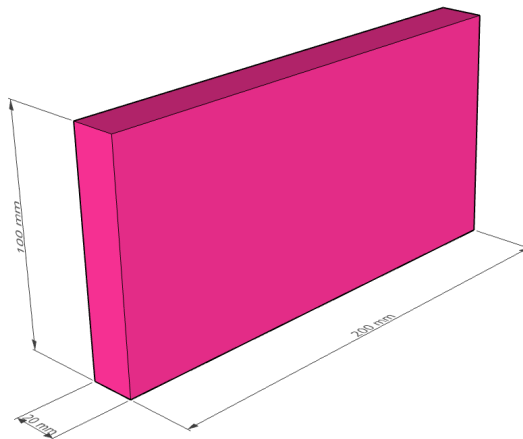

Figure 13: Dimensions of the parking lot limitations

14. Glossary

Check Time	During the check time, the judge will look at the vehicle and check the measurements (e.g., with a cube or a folding rule) and other technical requirements. A check needs to be done before every round.
Coach	A person assisting a team in the process to learn different robotics aspects, teamwork, problem solving, time management, etc. The role of the coach is not to win the competition for the team, but to teach them and guide them through the problem identification and in discovering ways to solve the competition challenge.
Competition organizer	The competition organizer is the entity that hosts the competition a team is visiting. This can be a local school, the National Organizer of a country that runs the National Final or a WRO Host Country together with WRO Association running the International WRO Final.
Competition	There are two types of rounds in the competition: qualification and final. The best performing teams after the qualification rounds participating in the final rounds.
Game field	The area which the vehicle must navigate within. The area may contain objects the vehicle must interact to as per the competition requirements.
GitHub repo	A storage for the source codes of the programs managed with the version control system Git. The storage is provided by the GitHub service (https://github.com/)
Round	A team runs an autonomous vehicle to complete the task of the challenge. The challenge score is based on the amount of laps the vehicle drives on the game field.
Practice Time	During the practice time, the team can test the vehicle on the field and the team can change mechanical aspects or the coding of the vehicle. Calibration is allowed during practise time.
Team	In this document the word team includes the 2-3 participants (students) of a team, not the coach who should only support the team.
Vehicle's control program	A set (or sets) of instructions for the vehicle's microprocessor/microcontroller to read values from the sensors and analyse this information and prior state of the vehicle as so to provide commands for the vehicle's motors to solve the challenge.
Driving Motor	The motors connected to the axles which are connected to the wheels. These motors move the vehicle forward or backward.
Steering Motor	The motor that steers the vehicle to the left or to the right direction.
WRO	In this document, WRO stands for World Robot Olympiad Association Ltd., the non-profit organization running WRO world-wide and that prepares all the game and rule documents.
Driving direction	The direction in which the vehicle must move during the challenges. This is determined through the randomization.

Appendix A: Explanatory schemes

1. Meaning of moved or knocked down traffic sign

On the schemes below the traffic signs are considered as:

- (a) – not **moved**
- (b) – **moved**
- (c) – moved but does not cause the round stop
- (d) – knocked down but does not cause the round stop
- (e) – moved and causes the round stop
- (f) – knocked down and causes the round stop

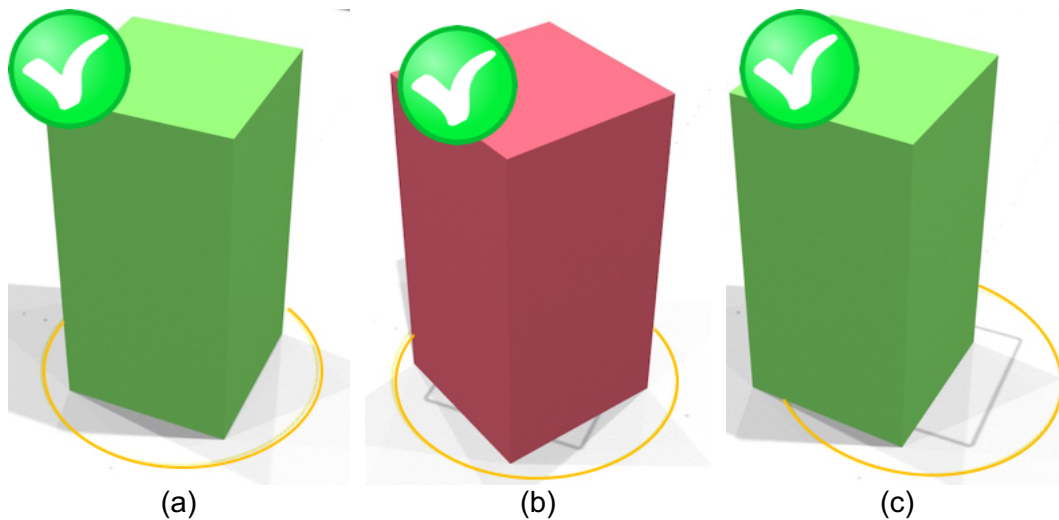
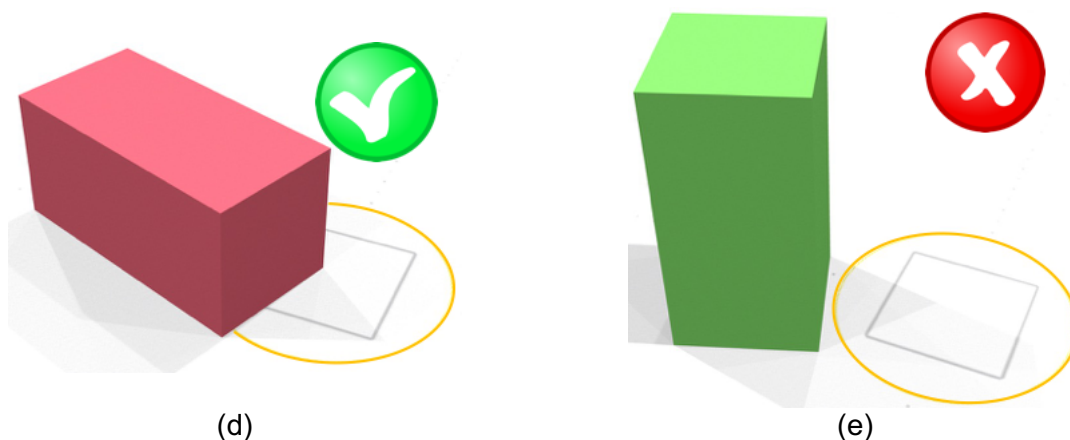
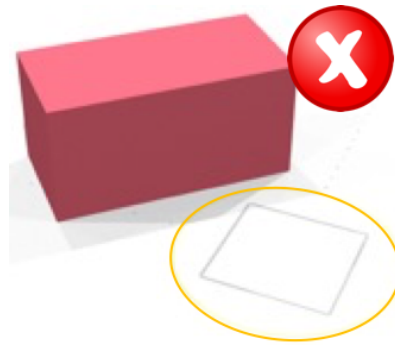

Figure 14:

- a) initial position of the traffic sign at the round start
 b) the traffic sign is not on the seat but still within the circle
 c) the traffic sign is partially outside of the circle and considered as **moved**





(f)

Figure 15:

- d) knocked down traffic sign is partially outside of the circle**
- e) the traffic sign is moved completely outside of the circle**
- f) knocked down traffic sign is completely outside of the circle**

2. Conditions to get points for finishing in the starting section

To identify if the vehicle finished within the starting section or not, the projection of the vehicle on the mat is used after full stop. If any part of the projection is outside of a straightforward section where the starting zone is located, the vehicle is considered outside of the starting section.

Consideration if the vehicle is within the starting zone or not is possible only if the vehicle stopped and has not moved for at least 30 seconds.

The starting zone on the schemes below is marked by the green colour.

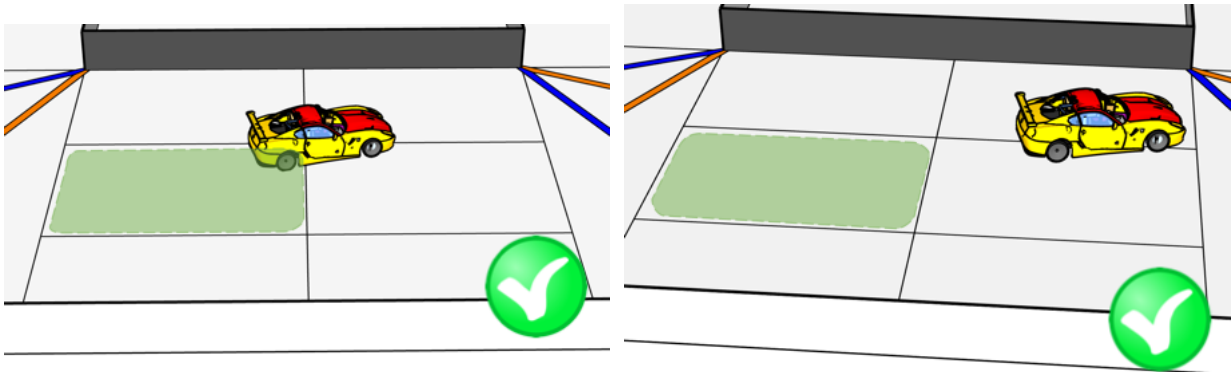

Figure 16: The vehicle finished completely within the starting section

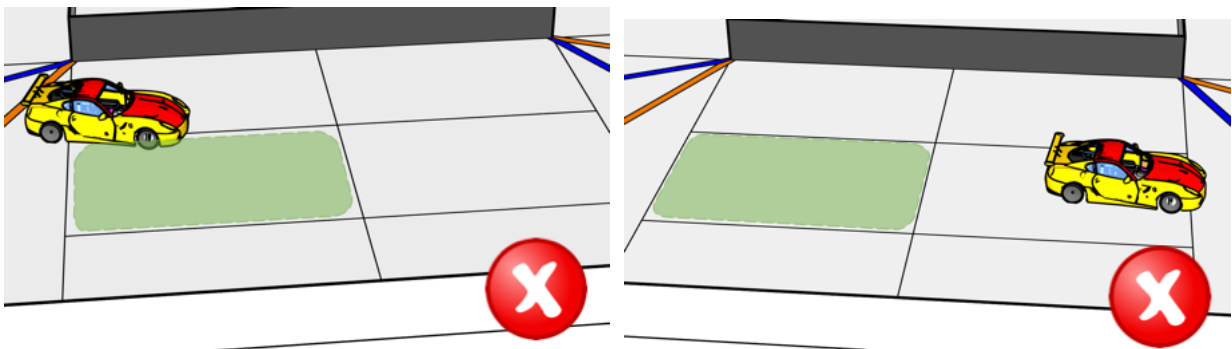

Figure 17: The vehicle finished outside of the starting section

3. Passing the starting section after three laps

The judges will end the round as soon as, after driving three laps, the vehicle passes the starting section.

When three laps are completed, the following phases are possible:

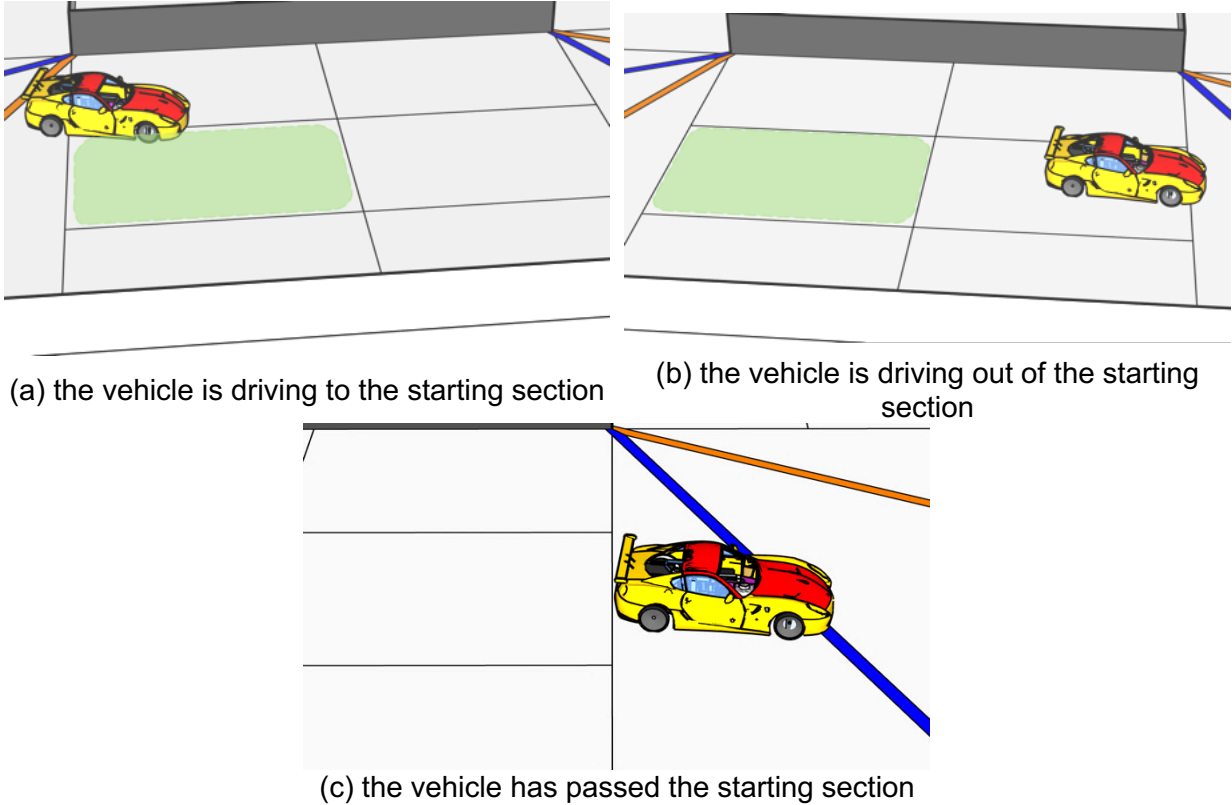
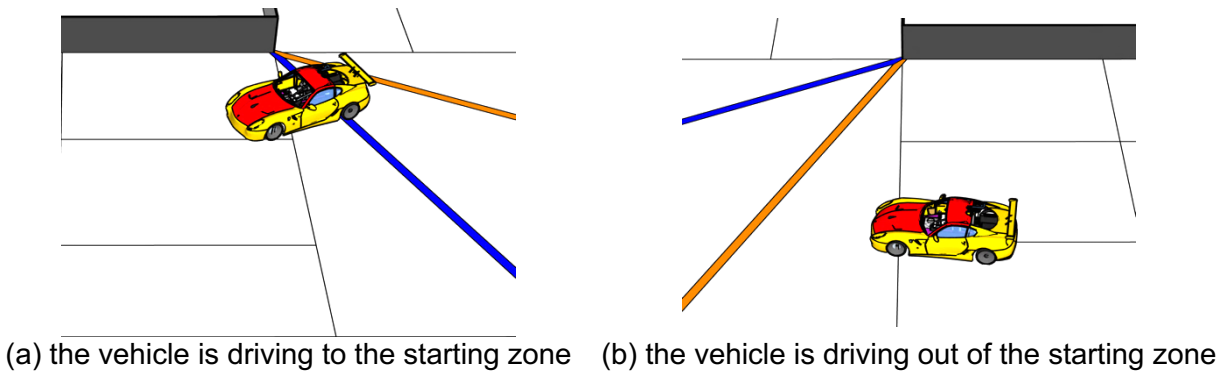
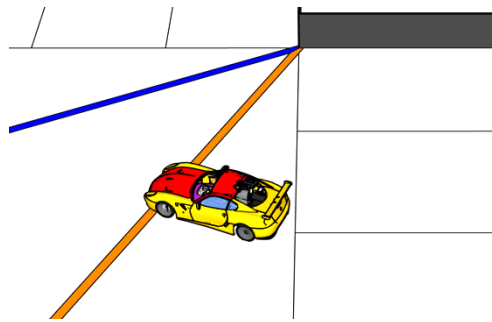

Figure18: Phases of passing the starting zone by the vehicle moving CCW

If the vehicle is still moving the judge will not stop time at the phases (a) and (b). But as soon as the vehicle is completely in the corner zone, the phase (c), the round will be ended.

The same is applicable if the round driving direction is clockwise.





(c) the vehicle has passed the starting zone

Figure 19: Phases of passing the starting zone by the vehicle moving clockwise

4. Driving in the opposite direction

During the round the vehicle is allowed to drive in the direction opposite to the round driving direction for two sections only: the section where the direction was changed and the neighbour section.

Let's consider the several cases:

Case 1: the vehicle started driving in the opposite direction and stopped completely within the neighbouring section

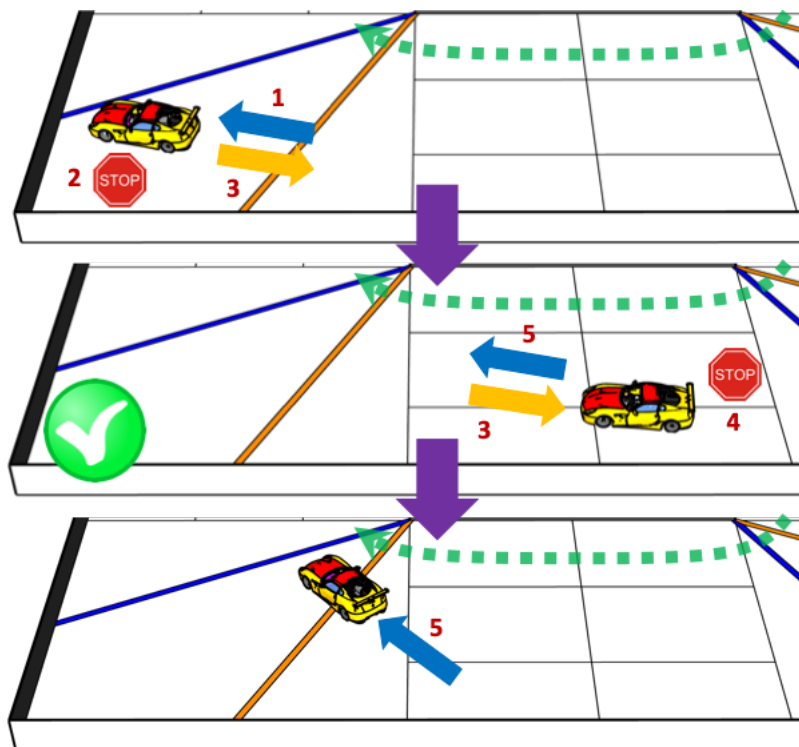

Figure 20: Allowed driving in the opposite direction from the corner section

On the figure above the round driving direction is clockwise (presented by the green dotted arrow near to the wall):

- phase 1: the vehicle arrived in the corner section
- phase 2: it stopped

- phase 3: it started driving back
- phase 4: the vehicle stopped in the straightforward section *without crossing the section boundary with the next section*
- phase 5: it continued driving in the round driving direction.

Such manoeuvre is allowed.

Case 2: the vehicle started driving in the opposite direction and stopped on the line between two sections

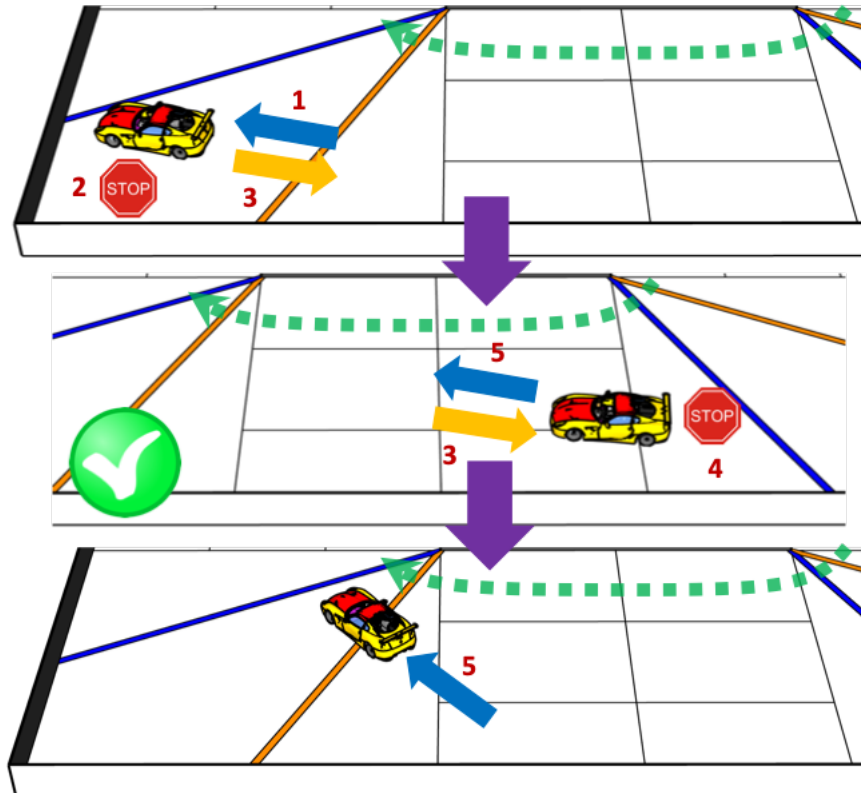

Figure 21: Allowed to stop at the boundary between the next section and the section after it while driving in the opposite direction

On the figure above the round driving direction is clockwise (presented by the green dotted arrow near to the wall):

- phase 1: the vehicle arrived in the corner section
- phase 2: it stopped
- phase 3: it started driving back
- phase 4: the vehicle stopped *at the boundary between the next section and the section*
- phase 5: it continued driving in the round driving direction.

Such sequence of movements is also allowed

Case 3: the vehicle started driving in the opposite direction and moved completely outside the neighbouring section

If the vehicle passes the boundary between the neighbour section and the section after it, the round will be stopped.

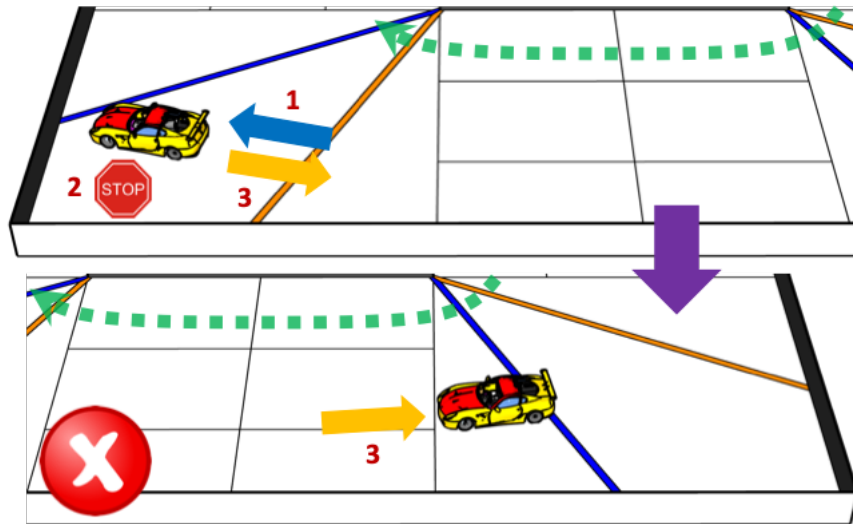

Figure 22: Moving completely outside of the neighbour section while driving in the opposite direction is not allowed

On the figure above:

- phase 1: the vehicle is initially moving in the round driving direction which is clockwise (presented by the green dotted arrow near to the wall)
- phase 2: it stopped
- phase 3: it started driving in the opposite direction and crosses two sections as, so it is completely outside of the neighbouring section.

Case 4: the vehicle changed the direction on the border between two sections

If the vehicle changed the direction when its projection on the field crossed the line between two sections, the forward section is considered as the first one to determine the farthest section which is allowed to drive in the opposite direction.

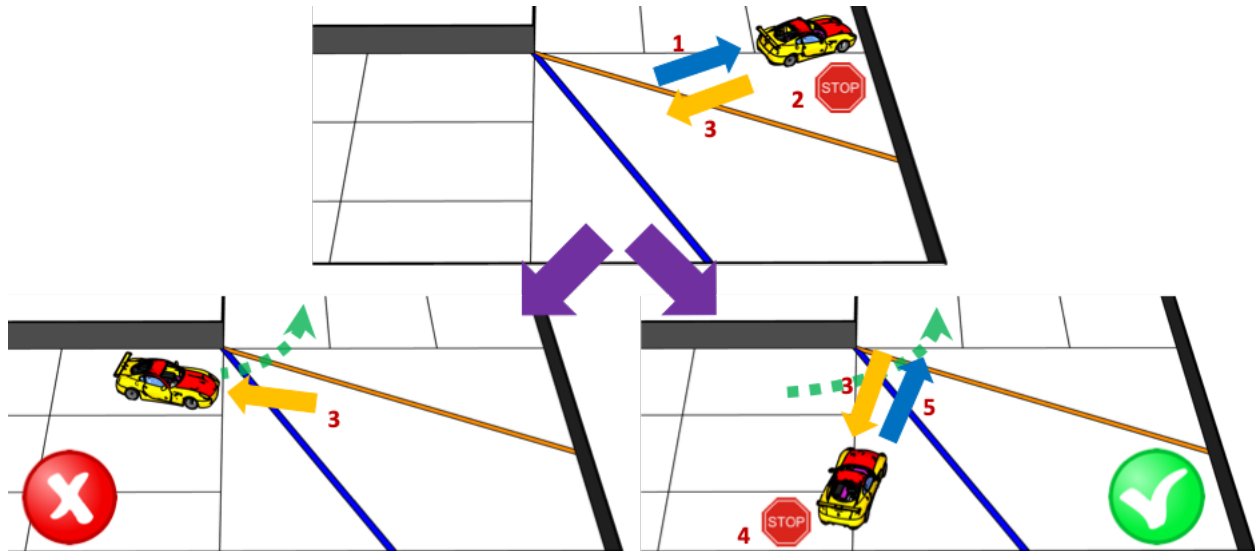

Figure 23: The farthest section to drive in the opposite direction when the vehicle stopped partially in the section

On the left side of the figure above the final of the following scenario is considered:

- phase 1: the vehicle initially drove through track CCW (reflected by the green dotted arrow near to the wall)
- phase 2: it stopped on the line between two sections – the forward section in the round driving direction is considered as the section where the direction was changed
- phase 3: it continued driving in the opposite direction and passed completely the section which is the neighbour to the section where the direction was changed.

Such behaviour will lead to the immediate stop of the round.

The scenario in which the round continues is considered:

- phase 1: the vehicle initially drove through track CCW (reflected by the green dotted arrow near to the wall)
- phase 2: it stopped on the line between two sections – the forward section in the round driving direction is considered as the section where the direction was changed
- phase 3: it changed the direction and started moving in the opposite direction
- phase 4: the vehicle stopped at the border of two sections
- phase 5: it continued driving CCW

Since the vehicle's projection is still partially in the neighbouring section the round is not stopped.

Case 5: changing the direction several times

The vehicle is allowed to change the direction several times but the farthest section to drive in the opposite direction is considered based on the closest to the finish section where direction was changed the first time:

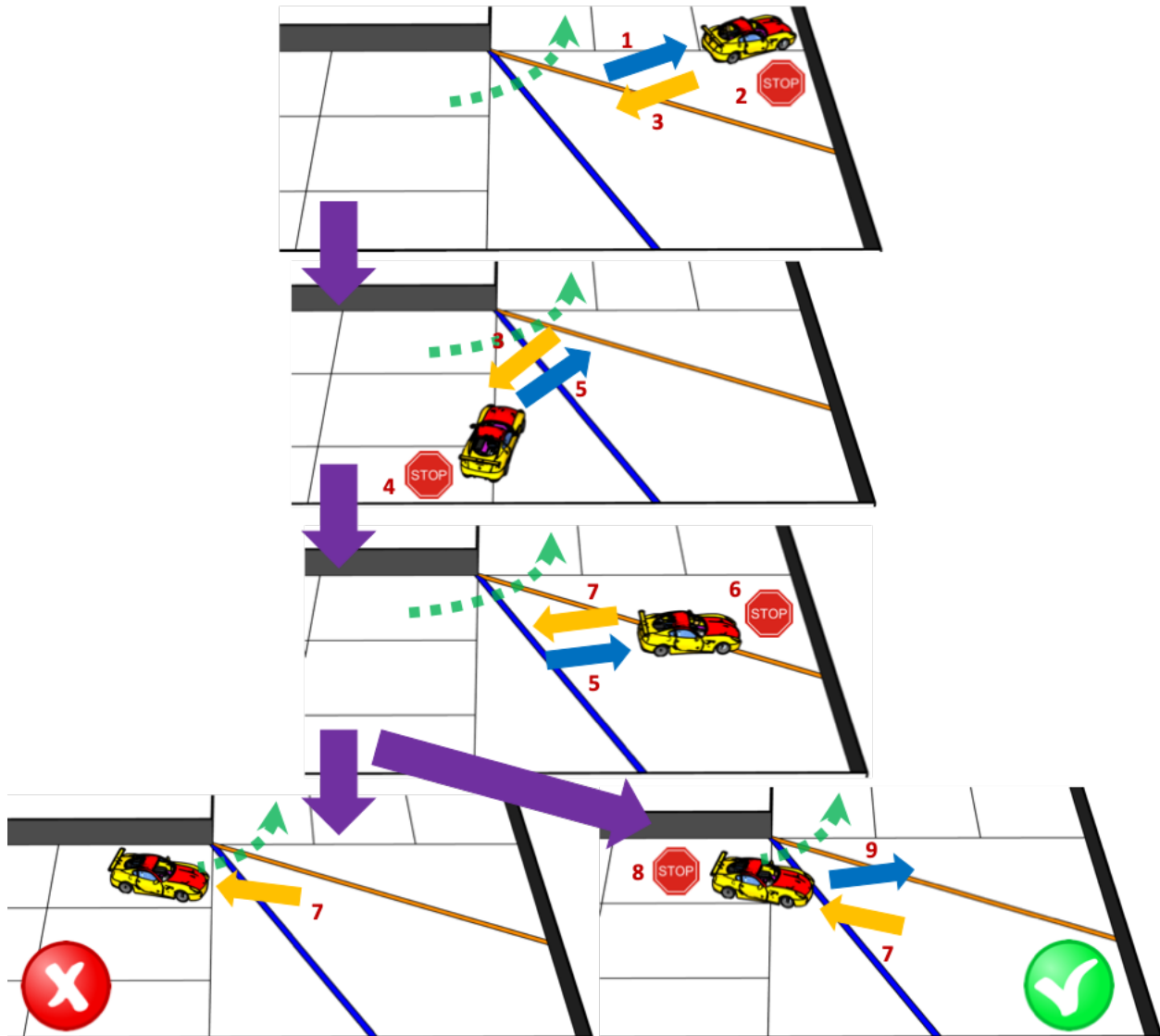

Figure 24: Allowance of changing the direction several times considered based on the closest to the finish section

The figure above allows to consider different outcomes for the case when the vehicle is changing the direction several times:

- phase 1: the vehicle initially drove through track CCW (reflected by the green dotted arrow near to the wall)
- phase 2: it stopped on the line between two sections – the forward section in the round driving direction is considered as the section where the direction was changed
- phase 3: it changed the direction and started moving in the opposite direction

- phase 4 and 5: the vehicle stopped in the neighbouring section – next to the section where the direction was initially changed then continued moving in the correct direction
- phase 6 and 7: the vehicle changed direction one more time, but this is not considered since the previous section where the direction was changed to opposite is closer to the finish
- if the vehicle completely goes out of the neighbouring section driving opposite the math will be stopped (the left side of the figure)
- if only part of the vehicle's projection is in the section next to the neighbouring section, this will not be considered as a reason to stop the round (the right side of the figure)

Case 6: Driving back-to-front

Hint: Old case 6 “passing traffic sign in the opposite direction” has been removed.

Driving back-to-front is allowed if the vehicle is being moved in the round driving direction.

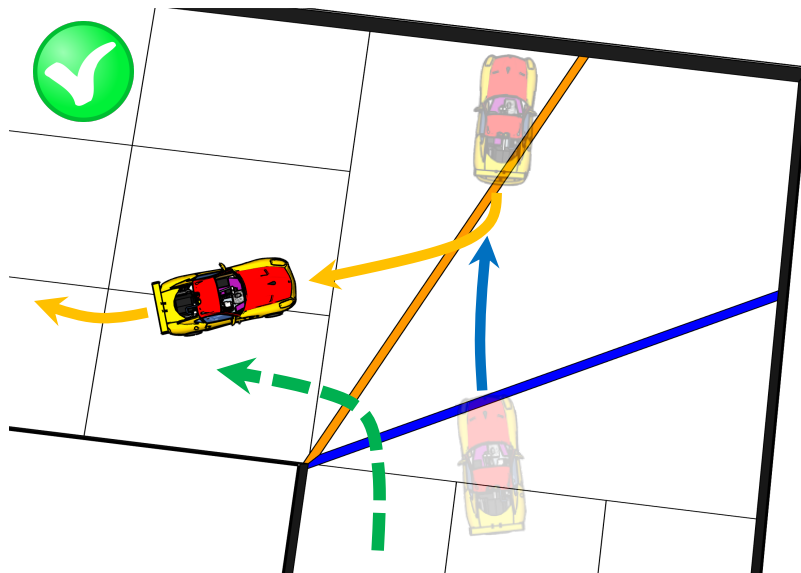

Figure 25: Back to front driving in the round driving direction

In this direction the rules to pass the traffic signs are applied to the vehicle in the same manner – the red pillar must be passed from the right; the green pillar must be passed from the left.

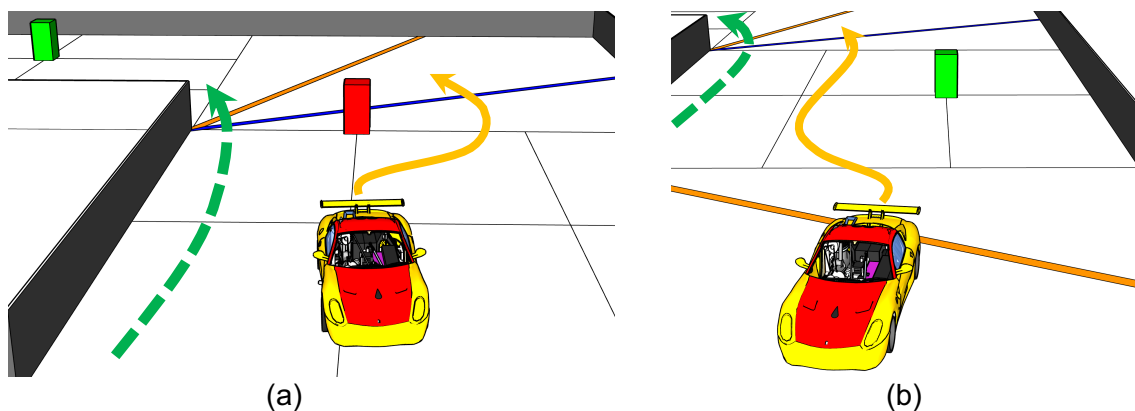

Figure 26: The rules to pass the traffic signs while driving back-to-front

5. Passing traffic signs from the incorrect side

Although it is not allowed to pass traffic signs from the incorrect side, a threshold exists that can be used by the vehicle to recognize the fault state and fix the behaviour.

If the vehicle started passing the traffic sign improperly the time will not be stopped if the vehicle does not pass completely the line that goes from the interior wall to the exterior wall (later, – radius) and where the traffic sign is located.

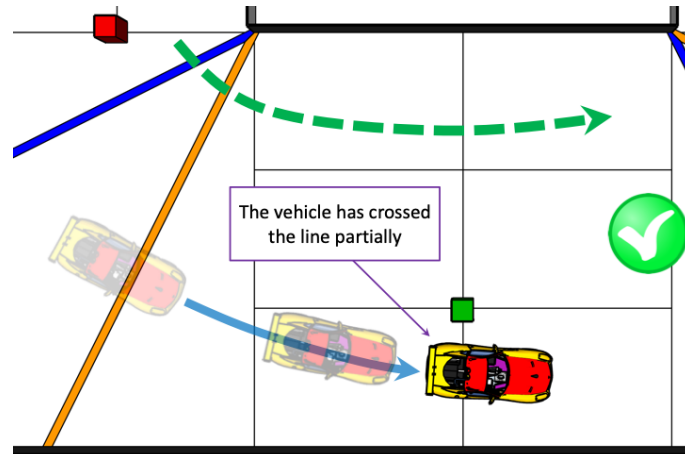

Figure 27: The vehicle does not pass the radius while driving from the right of the green pillar

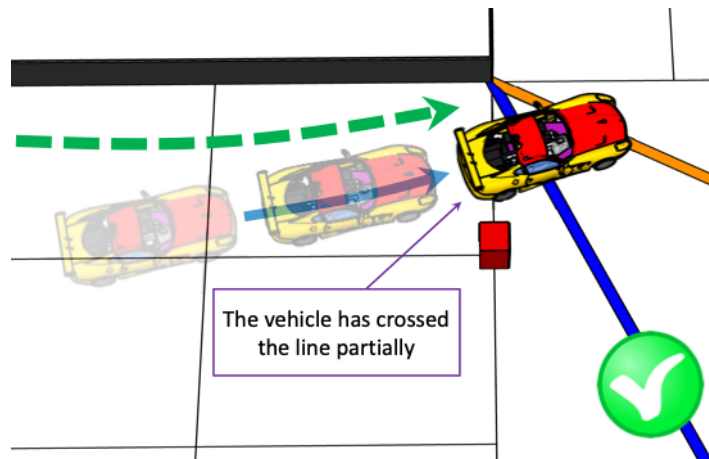

Figure 28: The vehicle does not pass the radius while driving from the right of the red pillar

As soon as the radius is completely crossed by vehicle judges will stop the round.

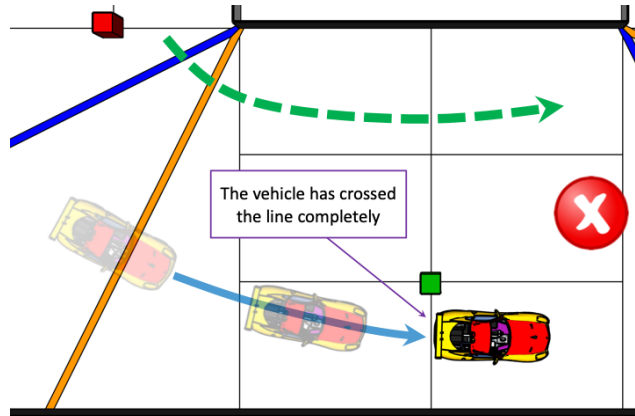

Figure 29: The vehicle completely crosses the radius from the right side of the green pillar

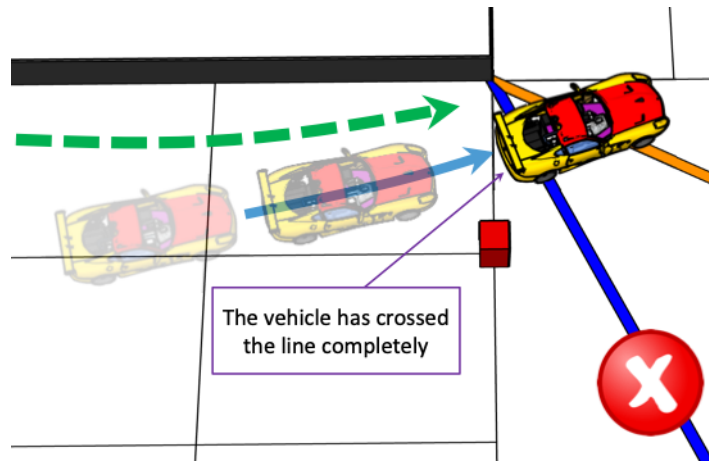

Figure 30: The vehicle completely crosses the radius from the left side of the red pillar

The same is applicable for the case when the vehicle is moving back-to-front in the round driving direction.

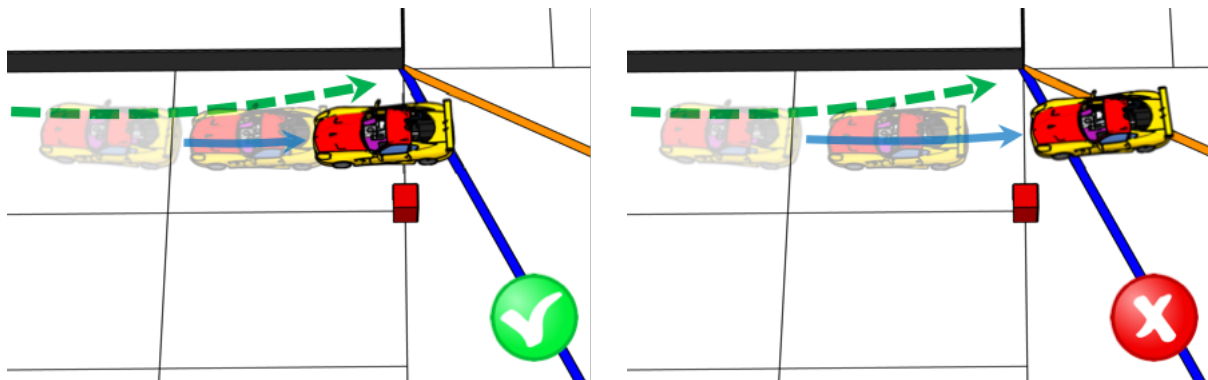

Figure 31: The vehicle passes the radius while driving back-to-front

In the obstacle challenge traffic signs only have to be obeyed on the three official laps. On the subsequent route to the parking lot, they can be bypassed to the right or left as desired. Moving them is still not permitted.

6. Parking in the parking lot

A robot is considered fully parked, when the projection of the robot on the mat is fully inside the rectangle between the two markers of the parking lot.

Hint: Compare to an earlier version of the document only the projection is important to decide if a robot is fully parked.

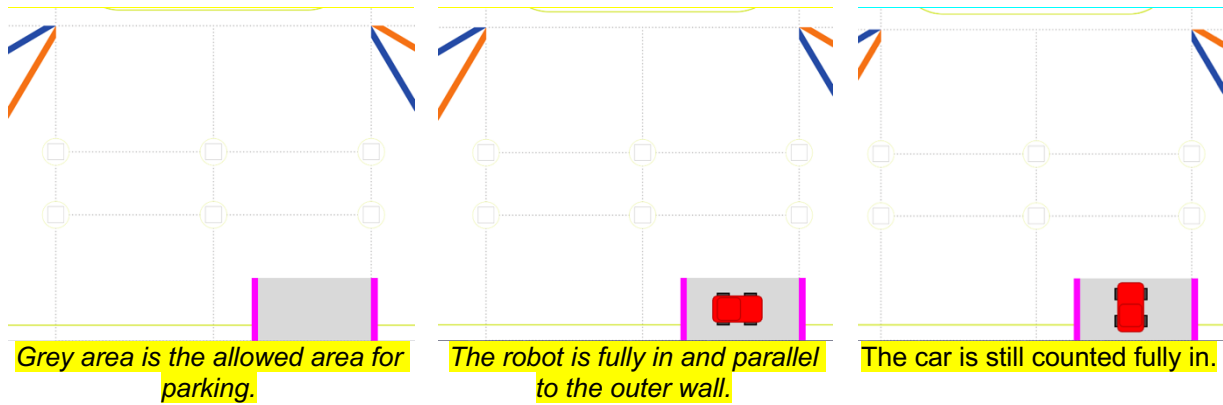

Figure 32: Fully parked situations

The robot is considered partly parked, when the projection of the robot on the mat is partly inside the parking lot.

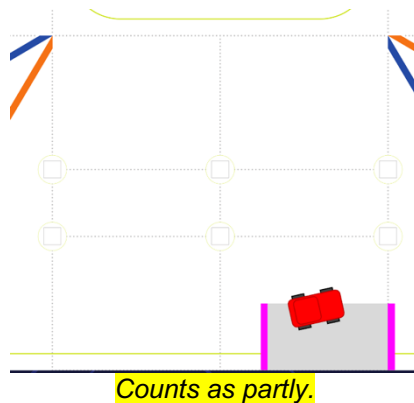

Figure 33: Partly parked situations

The parking lot limitations cannot be touched by the robot. When they are touched, the robot is stopped and no points for the parking can be scored.

Appendix B: Game field for national/regional finals

The main difference in the game field preparation for national/regional finals from the international final is how to build the interior wall, since the wall configuration depends on the randomization that happens before every qualification round.

Below is the recommendation that can be used to prepare segments of the interior wall.

First, this recommendation assumes that the material of the interior wall is wood/particleboard/MDF. Then, the wall consists of four parts: two long segments and two short segments and the thickness of every segment is the same. These segments are fixed together by using confirmat screws or dome screws and insert nuts. The height of the segments is 100 mm. The colour of the segments is black.

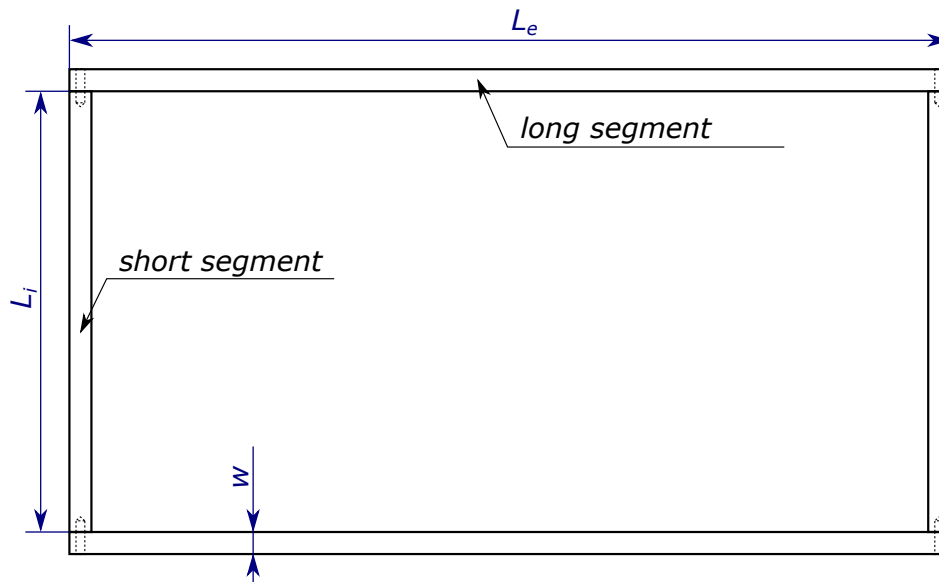

Figure 34: Scheme of segments used for the interior wall

So, all possible configurations of the inner wall could be achieved if the following sets of segments are prepared:

Long segments	Short segments
2 segments per 1000 mm	2 segments per $(1000 - 2w)$ mm
2 segments per 1400 mm	2 segments per $(1400 - 2w)$ mm
2 segments per 1800 mm	2 segments per $(1800 - 2w)$ mm
	where “ w ” is the thickness of a segment

For example, if the segment thickness is 17 mm, the lengths of short segments will be 966 mm, 1366 mm, and 1766 mm.

After the randomization prior to a round, the corresponding combination of segments is fixed together by screws and located on the field. To make the construction harder to move by the vehicle, some weight could be located on the inner side of the wall’s corners.

Appendix C: Engineering journal evaluation

The following guideline will be used to evaluate the engineering journal and vehicle documentation. Below is the list of scoring items and criteria for every item:

Scoring Area	Maximum Score
1. Mobility Management	4
2. Power and Sense Management	4
3. Obstacle Management	4
4. Pictures – Team and vehicle	4
5. Performance videos	4
6. GitHub utilization	4
7. Engineering Factor	4
8. Overall Judge impression	2
Total Score	30

The process to perform the vehicle documentation evaluation could be the following:

1. There are at least three judges which who will evaluate the documentation.
2. Every judge gets familiar with the vehicle documentation and provides his evaluation for every scoring item as per described criteria. The judge is not allowed to skip any scoring item. No discussion between judges is allowed at this moment. The evaluation of the item is based on the judge's understanding of the criteria and his feeling about how the corresponding criteria is reflected in the documentation – this is not a comparison of documentation materials provided by several teams between each other.
3. Average value for every scoring item is calculated based on the judges' marks.
4. The sum of all averaged scoring items is the total for the vehicle documentation for any particular team.

Rubric scale explanation

No evidence or discussion provided	Nothing provided
Inadequate	Too little information or information provided is not understood.
Needs improvement	Sufficient information is provided but it is clear that the effort cannot be duplicated.
Meets expectations	An exact duplication by another team can be made effortless from the information provided
Exceeds expectations	Not only can an exact duplication be made from the information provided, but information on improvements is also provided.

Rubric for judging engineering documentation

1	Mobility Management	
	Mobility management discussion should cover how the vehicle movements are managed. What motors are selected, how they are selected and implemented. A brief discussion regarding the vehicle chassis design /selection can be provided as well as the mounting of all components to the vehicle chassis/structure. The discussion may include engineering principles such as speed, torque, power etc. usage. Building or assembly instructions can be provided together with 3D CAD files to 3D print parts.	
	No evidence or discussion provided	0
	Inadequate	1
	Needs improvement.	2
	Meets expectations.	3
	Exceeds expectations	4

2	Power and Sense Management	
	Power and Sense management discussion should cover the power source for the vehicle as well as the sensors required to provide the vehicle with information to negotiate the different challenges. The discussion can include the reasons for selecting various sensors and how they are being used on the vehicle together with power consumption. The discussion could include a wiring diagram with BOM for the vehicle that includes all aspects of professional wiring diagrams.	
	No evidence provided or discussion provided	0
	Inadequate	1
	Needs improvement.	2
	Meets expectations.	3
	Exceeds expectations	4

Support information for wiring diagrams:

1. <https://www.edrawsoft.com/wiring-diagram.html>
2. <https://www.smartdraw.com/wiring-diagram/>
3. <https://www.doityourself.com/stry/3-different-types-of-electrical-wiring-diagrams-explained>
4. <https://www.allaboutcircuits.com/projects/build-your-own-robot-design-and-schematic/>

3	Obstacle Management	
	Obstacle management discussion should include the strategy for the vehicle to negotiate the obstacle course for all the challenges. This could include flow diagrams, pseudo code and source code with detailed comments.	
	No source code or discussion provided	0
	Inadequate	1
	Needs improvement.	2
	Meets expectations.	3
	Exceeds expectations	4

4	Pictures – Team and vehicle	
	Pictures of the team and robot must be provided. The pictures of the robot must cover all sides of the robot, must be clear, in focus and show aspects of the mobility, power and sense, and obstacle management. Reference in the discussion sections 1, 2 and 3 can be made to these pictures. Team photo is necessary for judges to relate and identify the team during the local and international competitions.	
	No Team or vehicle pictures provided	0
	Inadequate	1
	Needs improvement.	2
	Meets expectations.	3
	Exceeds expectations	4

5	Performance videos	
	The performance videos must demonstrate the performance of the vehicle from start to finish for each challenge. The videos could include an overlay of commentary, titles or animations. The video could also include aspects of section 1, 2 or 3.	
	No video evidence provided	0
	Inadequate	1
	Needs improvement.	2
	Meets expectations.	3
	Exceeds expectations	4

6	GitHub utilization	
	Git and GitHub are available for opensource project management and file version control. As part of the design and development process, teams must use this platform to document their progress, coding development and share files. Judging the platform will include how complete the information provided is, how information is structured and how often commits were done. Teams can use this platform to provide additional information on their engineering design and coding of their vehicle as well.	
	No evidence provided of GitHub use	0
	Inadequate	1
	Needs improvement.	2
	Meets expectations.	3
	Exceeds expectations	4

Support information for GitHub utilization:

1. <https://careerfoundry.com/en/blog/web-development/what-do-developers-use-github-for-heres-why-its-vital/>
2. [What is GitHub?](#)
3. <https://apiumhub.com/tech-blog-barcelona/using-github/>
4. <https://kinsta.com/knowledgebase/what-is-github/>
5. <https://en.wikipedia.org/wiki/GitHub>
6. <https://www.howtogeek.com/180167/htg-explains-what-is-github-and-what-do-geeks-use-it-for/>
7. <https://www.simplilearn.com/tutorials/git-tutorial>

7	Engineering Factor	
	No evidence provided or no description of design.	0
	Standard "Off the shelf" RC or modular construction kit with no design changes.	1
	Standard "Off the shelf" RC or modular construction kit with little design changes.	2
	Standard "Off the shelf" RC or modular construction kit with design changes and team added own designed components such as sensor mounts.	3
	Own Design and manufacturing of vehicle and components, with off the shelf electrical components, such as motors and sensors	4

8	Overall Judges impression	
	Info on GitHub is weak and poor communication of vehicle design and coding. Efforts cannot be duplicated.	0
	Info on GitHub is average communication of vehicle design and coding. Duplicating the efforts will not be easy.	1
	Info on GitHub is excellent communication of vehicle design and coding. It will be easy to duplicate the efforts.	2

Appendix D: Minimal set of electromechanical components

The list below represents the list of equipment which can be used for electromechanical parts of the vehicle. This is suggestion rather than the requirements. Teams are on their own to follow these suggestions or not.

- a single board computer: it will be used for real time video processing, analysing sensor data, sending/managing signals to the motor controller.
- a single board microcontroller + a motor shield: this combination of equipment receives managing signals from the main SBC and operates with motors correspondingly.
- a wide-angle camera
- two distance sensors
- two light sensors
- servomotor: it controls steering
- DC-motor with gearbox: it controls the vehicle's velocity
- at least one encoder: it allows the vehicle to measure angular velocity of a DC motor
- IMU (inertial measurement unit) – this is usually a combination of gyroscope and accelerometer: it can be used to improve the vehicle navigation
- two batteries: one is for SBC and SBM, another is for motors
- a voltage stabilizer: it is required to provide adequate power supply for the SBC/SBM
- two switches to connect batteries to the power consumers: SBC/SBM, motors
- push button: it could be used as a trigger to start the round

An example vehicle configuration could be:

- Chassis from a Remote Controlled (RC) Car
- The main controller -- Raspberry Pi 3 (<https://www.raspberrypi.org/products/raspberrypi-3-model-b-plus/>), and a MicroSD card to keep an operating system and programs.
- Camera module (<https://www.raspberrypi.org/products/camera-module-v2/>) with extra wide-angle lens
- The motor and sensor controller -- Arduino UNO (<https://store.arduino.cc/arduino-uno-rev3>) with a prototyping shield (<https://store.arduino.cc/proto-shield-rev3-uno-size>)
- DC Motor Controller (<https://www.robotshop.com/en/cytron-13a-5-30v-single-dc-motor-controller.html>)
- DC Motor to drive the vehicle (could be part of the chassis),
- Servo Motor for steering (could be part of the chassis)
- IMU sensor (<https://www.sparkfun.com/products/13762>)
- 2 Ultrasonic Distance Sensor (<https://www.sparkfun.com/products/15569>)
- 2 Analog Line sensors (<https://www.sparkfun.com/products/9453>)
- Rotary Encoder (<https://www.sparkfun.com/products/10790>)
- An external USB Battery with a hub to split the consumption between Raspberry Pi and Arduino
- Additional battery applicable to power the DC motor (could be part of the chassis)